

Mobile Optical Pluggables (MOPA)

Technical Paper

Version 1.1

March 9, 2022

Authors (in alphabetical order)

Alberto Artuso³
Antonio Bove²
Antonio Tartaglia¹
David Lewis²
David Sinicrope¹
Giacomo Losio²
Giampaolo Bendelli²

Fabio Cavaliere¹
François Fredricx⁴
James Kannan³
Jun Pan⁵
Justin Abbott²
Ken Cockerham⁵
Kengo Matsumoto³

Kenneth Jackson³
Kohei Tazaki³
Lieven Levrau⁴
Ole Reinartz⁴
Ronald Heron⁴
Stefan Dahlfors¹

(1) Ericsson, (2) Lumentum, (3) Sumitomo Electric, (4) Nokia, (5) II-VI.

1. Executive summary

The spectrum allocations for the 5th generation mobile systems are growing as well as the rollouts of live 5G networks. These require transport network capacity growth, resulting in an urgent and significant need for high-capacity and cost-effective optical solutions as part of those 5G transport networks.

Currently, however, there is a lack of a shared and common view for the optical solutions needed for mobile transport [OptConn]. This has several implications:

- Technological and architectural: a plethora of different architectures and technologies.
- Cost: challenging choices for operators, system vendors and optical pluggables suppliers to focus on the most relevant needs.
- Availability: the right solution may not be commercially available at the right time and at the right cost point.

An improved common understanding and focus can be achieved by making *mobile optical blueprints* resulting in:

- Clear optical pluggable needs for operators, systems vendors and optical pluggable suppliers.
- An eco-system ensuring timely, cost-efficient, and optimized architectures.

By *mobile optical blueprint* we mean a *network solution description* documenting a use case with the optical pluggables and passive optical components (wavelength division multiplexing (WDM) mux, splitter, etc.) implementing that use case, with high-level optical and pluggables requirements.

The Blueprints in this paper—nineteen in total—cover all globally relevant deployment variants for distributed radio access networks (DRAN), centralized RAN (CRAN) and virtualized RAN (VRAN) for the links connecting the radio units (RUs) with distributed units (DUs), DUs with centralized units (CUs), and CUs with the mobile core.

In light of new needs for mobile optical networks, this 1.1 version adds the following compared with the 1.0 version from June 2021: 50 Gb/s line rate added to some Blueprints and adding references to existing optical layer interface standards in the Blueprint tables where applicable.

Contents

1. Executive summary.....	2
2. Introduction, purpose and scope.....	5
3. Acronyms.....	6
4. Legend.....	7
5. Background: 5G evolution and optical impact	9
6. Generic optical solutions requirements in mobile transport networks.....	12
6.1. Operating temperature and power consumption classes.....	12
6.2. EMI and EMC.....	13
6.3. Latency	13
6.4. Synchronization.....	13
6.5. Support of multiple bit rates.....	13
6.6. Form factor standards.....	13
6.7. Connectors: UPC, APC.....	14
6.8. Tunable and automatic self-tunable DWDM pluggables.....	14
6.9. Loss budget (channel insertion loss) and chromatic dispersion.....	14
6.10. Lifespan of optical pluggables.....	16
7. Mobile Optical Solution Blueprints for LLS in Distributed RAN (DRAN).....	17
7.1. Overview	17
7.2. DRAN Optical Blueprints	20
7.2.1. 2 km RU-DU direct parallel fibers, dual and BiDi fiber Blueprint.....	20
7.2.2. 10 km RU-DU direct parallel fibers, dual and BiDi fiber Blueprint.....	21
8. Mobile Optical Solution Blueprints for LLS in Centralized RAN (CRAN).....	22
8.1. Overview	22
8.2. CRAN Optical Blueprints	25
8.2.1. 15 km RU – DU direct parallel fibers, dual and BiDi fiber Blueprint	25
8.2.2. 10 km RU – DU, passive CWDM over a single fiber Blueprint	26
8.2.3. 15 km RU-DU, passive DWDM over a single fiber Blueprint.....	27
8.2.4. 15 km RU-DU, passive DWDM bus over a single fiber Blueprint.....	28
8.2.5. 15 km RU-DU, semi-active DWDM over a single fiber Blueprint.....	29
8.2.6. 2 km RU-DU packet multiplexing, dual or BiDi fiber Blueprint	30
8.2.7. 15 km RU-DU packet multiplexing, dual or BiDi fiber Blueprint	31

9.	Mobile Optical Solution Blueprints for Backhaul and HLS	32
9.1.	Overview	32
9.2.	Backhaul and HLS Optical Blueprints	34
9.2.1.	2 km DRAN intraoffice backhaul, direct parallel fibers, dual fiber Blueprint.....	34
9.2.2.	10 km DRAN backhaul, direct parallel fibers, dual and BiDi fiber Blueprint.....	35
9.2.3.	40 km DRAN backhaul, direct parallel fibers, dual and BiDi fiber Blueprint.....	36
9.2.4.	15 km DRAN backhaul, passive DWDM bus over a single fiber Blueprint	37
9.2.5.	2 km CRAN intraoffice backhaul, direct parallel fibers, dual fiber Blueprint.....	38
9.2.6.	10 km CRAN backhaul, direct parallel fibers, dual and BiDi fiber Blueprint	39
9.2.7.	40 km CRAN backhaul, direct parallel fibers, dual and BiDi fiber Blueprint	40
9.2.8.	15 km CRAN backhaul, passive DWDM over a single trunk fiber Blueprint	41
9.2.9.	20 km DRAN Backhaul and HLS with TDM-PON, Separate ONU box Blueprint.....	42
9.2.10.	20 km DRAN Backhaul and HLS with TDM-PON, Pluggable ONU	43
10.	Summary of Optical Pluggables needed per Blueprint.....	44
11.	Summary of important technologies, capabilities, and components not yet available	46
11.1.	Optical transceivers operating at high temperature	46
11.2.	Cost effective high-capacity transceivers	46
11.3.	Pluggable optical amplifiers and dispersion compensators	47
11.4.	Cost-effective tunable filters and wavelength switches.....	47
12.	Solutions under evaluation and future work.....	48
12.1.	LLS using TDM-PON with separate ONU box.....	48
12.2.	LLS using TDM-PON with pluggable ONU	49
12.3.	Higher speed TDM-PON technologies	49
12.4.	LLS using semi-active DWDM wavelength multiplexed links over a power splitter ODN (WS- WDM-PON)	49
12.5.	LWDM	50
13.	Conclusion.....	51
14.	References	52

2. Introduction, purpose and scope

From the International Mobile Telecommunications (IMT) 2020 vision [M2083] and resulting global and national efforts, the spectrum allocations for 5th generation mobile systems are growing and, consequently, also the transport capacity needs.

To better support the industry to optimize efficiency and time plans, this technical paper aims to describe uses of optical technologies and solutions across mobile transport in a clear way, as elaborated below.

This document is describing and clarifying what the authors think is needed for the mobile RAN equipment for optical pluggables. This description makes it clear what function is needed and lowers barrier to entry by making it clear what to develop for the RAN equipment environment without wasting time and investment on unnecessary solutions for which there is no demand. Ideally this would result in robust, competitive offerings of optical components and solutions for the mobile environment to the ultimate benefit of consumers.

By mobile transport we mean networks to connect RAN equipment such as RUs, DUs and CUs, including eNodeB and gNodeB, and also transport equipment such as cell site gateways and active WDM equipment dedicated to mobile traffic¹.

This paper outlines important RAN deployment cases (see e.g. [G8300]) and the optical solutions best suited to these cases. The solutions in this paper are called *mobile optical solution blueprints*, or just Blueprints, encompassing the optical technologies—mainly optical pluggable modules but also accompanying components such as WDM filters—best suited to satisfy deployment needs. Optical pluggables are defined as front-panel pluggable optical transceivers in popular form factors like SFP+, SFP28, QSFP28, etc. and the Blueprints are intended as global solutions, i.e., as generic as possible to cover a wide range of network scenarios.

This paper organizes and integrates existing standards and implementation agreements produced by Standards Development Organizations (SDO), Industry Fora and multi-source agreements (MSAs), where the Blueprints cover the different technical aspects, forming a broad description of optical solutions useful and important for mobile transport networks.

This paper will look at the mid-term future identifying new Blueprints and possible new standardization activities considered of strategic interest for mobile transport networks.

Another way to clarify the important optical solutions for mobile transport is to classify them according to

1. Important solutions with wide consensus in the mobile transport industry.
2. Solutions still discussed where the importance is not yet concluded/agreed.
3. Solutions with a wide consensus not seen as important in the mobile transport industry.









The paper mainly deals with the first category, with some examples of the second outlined in Section 12.

¹ In this document, RAN node terminology is reused from [TS38306], [TS38470] and [GSTR-TN5G].

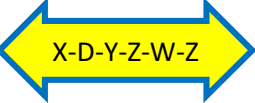
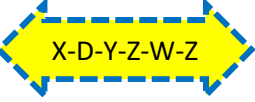
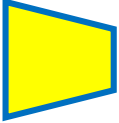
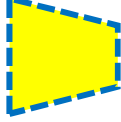
3. Acronyms

5G	5th Generation mobile networks, generic term for 5G system (or sometimes just the RAN part)
5GC	5G core, packet core part of 5G system
AAV	Alternative Access Vendor
APC	Angled Polished Connector
AWG	Arrayed Waveguide Grating (optical DWDM multiplexer)
BiDi	BiDirectional (using a single fiber strand for both transmission directions from an optical pluggable pair, where the two directions use different wavelengths)
C-band	The conventional fiber transmission band, around 1550 nm (aka “3rd window”)
CapEx	Capital expenditure
CD	Chromatic Dispersion
CO	Central Office
CRAN	Centralized RAN
CPRI	Common Public Radio Interface
CU	Central Unit
CWDM	Coarse WDM (20 nm wavelength spacing)
DCO	Digital Coherent Optics
DDM	Digital Diagnostics Monitoring
DFB	Distributed Feedback (laser)
DRAN	Distributed RAN
DWDM	Dense WDM (≤ 0.8 nm wavelength spacing in C-band)
DU	Distributed Unit
FP	Fabry-Pérot (laser)
HLS	High-Layer Split
IL	Insertion Loss
LC	Optical Connector
LLS	Low-Layer Split
LWDM	Local Area Network (LAN) WDM
MSA	Multi-Source Agreement
NR	New Radio, RAN part of 5G system
NRZ	Non-Return to Zero modulation
O-band	The original fiber transmission band, around 1310 nm (aka “2nd window”)
ODN	Optical Distribution Network
ONU	Optical Network Unit (for TDM-PON)
OLT	Optical Line terminal (for TDM-PON)
OpEx	Operational expenditure
OPP	Optical Path Penalty
P2MP	Point-to-multipoint
P2P	Point-to-point
PAM4	Pulse Amplitude Modulation, 4 levels
Phy	Physical layer (optical)
Pkt	Indicates a node for packet switching and aggregation. May include mapping CPRI to packet, TDM to packet, etc.
QSFP	Quadruple-density Small Form Factor Pluggable
RAN	Radio Access Network
ROSA	Receive Optical Sub-Assembly
RU	Radio Unit
SDO	Standards Development Organization
SFP	Small Form factor Pluggable
STO	Self-Tuning Optic
TOSA	Transmit Optical Sub-Assembly
VRAN	Virtual RAN
WDM	Wavelength Division Multiplexing. In a node, WDM indicates an active WDM equipment, also known as a WDM transponder
WR	Wavelength Routed
WS	Wavelength Selected

4. Legend

	RAN Network Element
	Transport node: WDM or Pkt
	Optical Pluggable of type X-D-Y-W-Z, industrial temperature range ("I-temp")
	Optical Pluggable of type X-D-Y-W-Z, commercial temperature range ("C-temp")
	Optical (passive) multiplexer, industrial temperature range ("I-temp")
	Optical (passive) multiplexer, commercial temperature range ("C-temp")
	Fiber (generic)
	Fiber pair
	BiDi fiber (single fiber strand)
	Optical power splitter
	Pluggable device with integrated Transport node functionality and optics

The optical pluggable *type* in the icons above is meant to provide an indication at a glance of the category to which the transceiver belongs. It is meant to be a compact and not all-encompassing description: detailed characteristics are provided in the optical Blueprints description in sections 7-9. The semantic of the different type fields is reported in Table 1.

X Bit rate	D Distance	Y1 Wavelength region(s)	Y2 WDM grid	Y3 Number of wavelengths/ fiber strand	W Fiber mode 1=BiDi 2=dual	Z Form factor
10G 25G 50G 100G 200G 400G GPON XGSPON 25GSPON	2 km 5 km 10 km 15 km 20 km 40 km 80 km	O (1260-1360 nm) E (1360-1460 nm) S (1460-1530nm) C (1530-1565nm) L (1565-1625nm) *** (all bands, only for CWDM)	G – gray (wavelength generic) B1 – BiDi 1270nm/1310nm B2 – BiDi 1270nm/1330nm B3 – BiDi xxxx / yyyy nm L – LAN-WDM (4.5nm) D – DWDM (100 GHz, 0.8nm) DL – DWDM with wavelocker (50 GHz, 0.4nm) C – CWDM (20nm)	1 2 4 6 8 12 16 48 96	1 2	SFP+ SFP28 SFP56 QSFP+ QSFP28 QSFP56 QSFP-DD QSFP-DD56 SFP-DD SFP-DD56 DSFP DSFP56 (prefix T is used for tunable)

Table 1: Optical pluggables codes nomenclature².

Some use examples of this nomenclature are reported below:

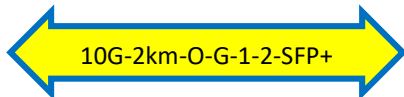

10G SFP+ 2 km "gray" (1310nm)

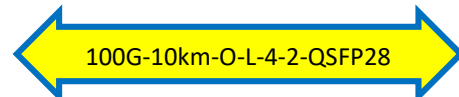

100G 10 km QSFP28 using the 4λ LAN-WDM grid

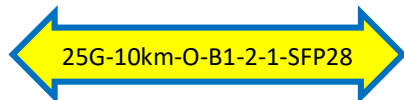

25G 10km SFP28 BiDi (1270nm/1310nm)

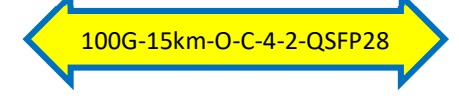

100G QSFP28 using the CWDM4 grid

Figure 1: Example of icons and codes for "client" pluggables.

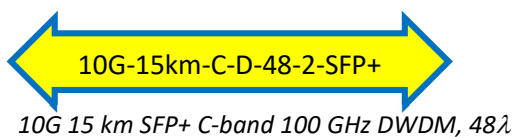

10G 15 km SFP+ C-band 100 GHz DWDM, 48λ

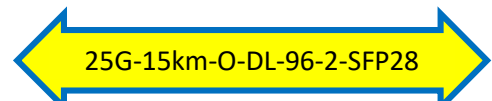

25G 15 km SFP28 O-band DWDM, 96λ

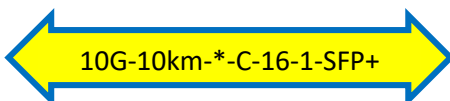

10G 10 km SFP+ CWDM BiDi 16λ

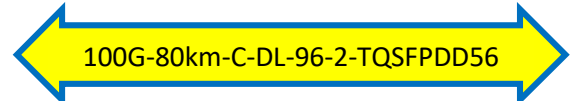

100G 80 km QSFP-DD56 C-band (coherent) DWDM, 96λ

Figure 2: Example of icons and codes for "line" pluggables.

² It should be noted that some values and variants are not yet used for the Blueprints of this paper, e.g. the distances 5, 20 and 80 km

5. Background: 5G evolution and optical impact

With 5G research starting in the early 2010s [Wiki5G], and standardization efforts in 3GPP and ITU starting a few years later the goals were to provide an enhanced mobile broadband experience as well as add capabilities for very scalable cellular network for massive machine type communications (MMTC), and ultra-reliable and low-latency communications (URLLC). This is described in ITU-R M.2083 [M2083] and illustrated in Figure 3.

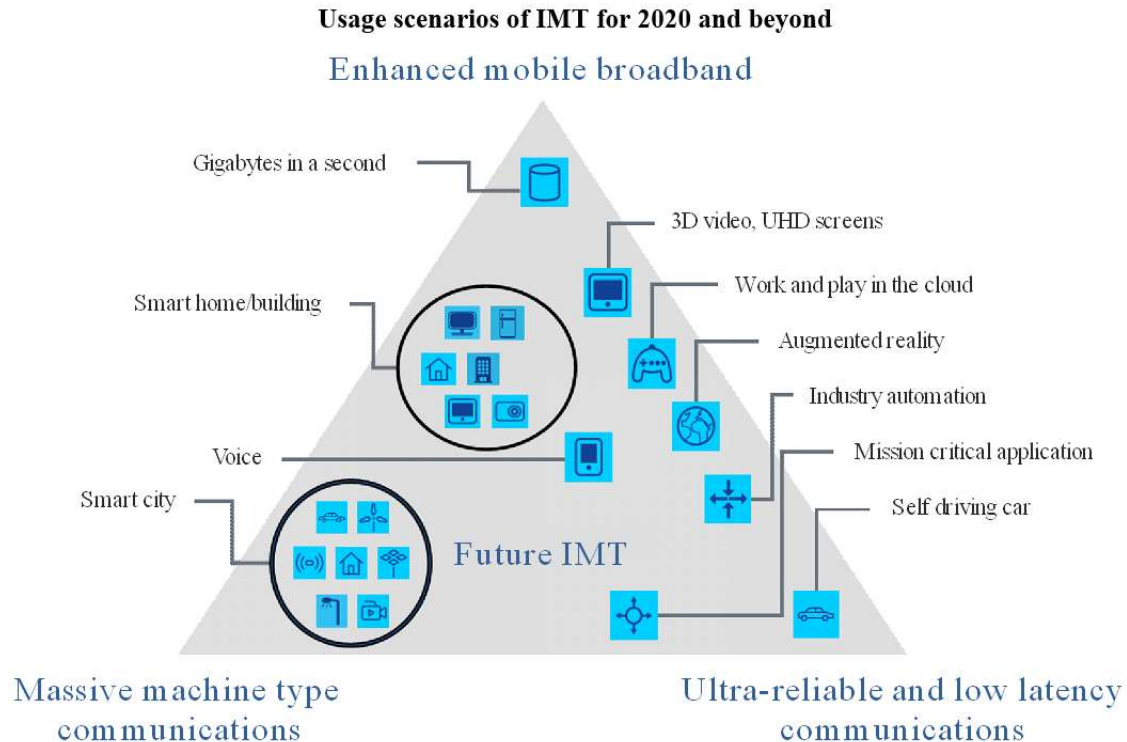

M.2083-02

Figure 3: IMT 2020 vision from ITU-R M.2083.

For the first goal, much larger pieces of spectrum are planned for 5G compared to LTE (see [LTEbands], [NRbands]) and bands can be combined for even more spectrum.

With such wide spectrum, the peak data rates for a radio unit can reach well beyond 10 Gb/s (see Section 4.1.2 in [TS38306]). Thus, the physical line rates for the optical pluggables used in radio units must be at least 10 Gb/s, often 25 Gb/s with 50 Gb/s and 100 Gb/s as next steps.

Another driving factor is the consolidation of RAN baseband processing, performed by distributed units (DUs), to fewer locations: DUs are moved from the cell sites to central locations. Centralized RAN (CRAN) deployments started even before 5G and are steadily continuing also with the addition of small cells. Having said that, DRAN is today the dominant deployment variant. In CRAN, due to the longer distance between RUs and DUs, the interconnect is no longer simply cabling at the mobile site but becomes a transport network, making it more challenging to meet stringent latency requirements between RU and DU and

© 2022 Ericsson, Nokia, II-VI, Lumentum and Sumitomo Electric.

This document may be freely reproduced and distributed whole and intact including this Copyright Notice."

growing in complexity and cost. A generic name for the interface between RU and DU is Low-Layer Split (LLS, [TS38801]), where CPRI and eCPRI are common connectivity protocols, encapsulated in IP and Ethernet. High-Layer Splits (HLS) and the 3GPP F1 transport interface [TS38470] allow the partitioning into DU and CU, resulting in an architecture commonly referred to as virtual RAN³. Requirements for F1 transport are similar to the interfaces between RAN and the mobile core, i.e. S1 and N3 (for EPC and 5GC, respectively), commonly called backhaul [GSTR-TN5G].

Figures 4, 5 and 6 illustrate the architectures of DRAN. CRAN and virtual RAN, respectively⁴. A few things should be noted from the below figures:

- The illustrations are much simplified. For example, each cell site normally includes multiple RUs.
- All the architectures below have LLS, either locally at the site of for DRAN and virtual RAN or spanning sites as in the CRAN case.
- While the below figures explicitly show that DU and CU may be collocated, the illustrations in the rest of this paper may be less explicit. Unless “CU” nodes are explicitly illustrated, the “DU” nodes may include the CU function as well.

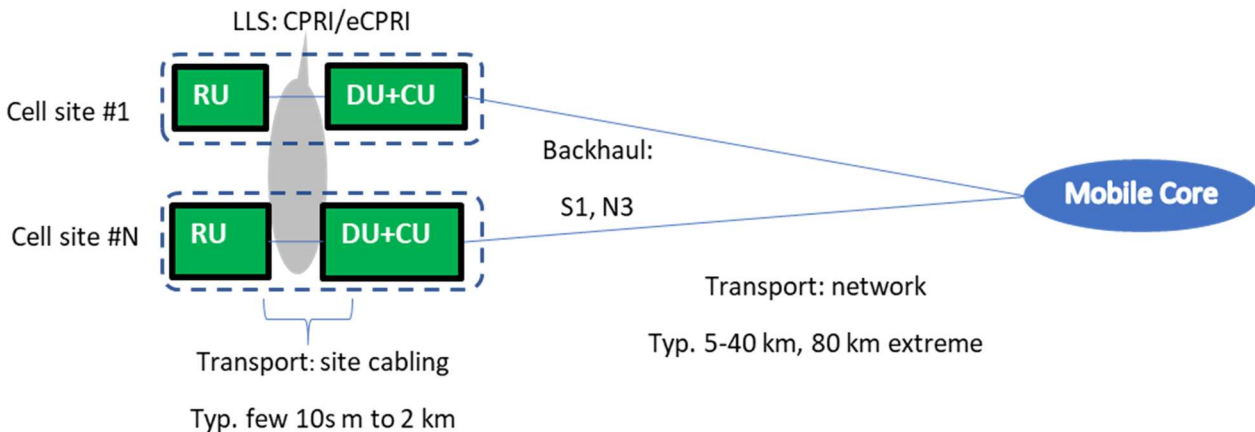

Figure 4: DRAN architecture. The LLS links are highlighted by the gray oval.

³ It should be noted that virtualization is a technology and not an architecture, but since one popular technology choice is to virtualize the CU function, the term virtual RAN is common.

⁴ In this paper, the network terms LLS and HLS are used instead of fronthaul, midhaul, x-haul etc., due to the ambition to be unambiguous and to use 3GPP terms whenever possible.

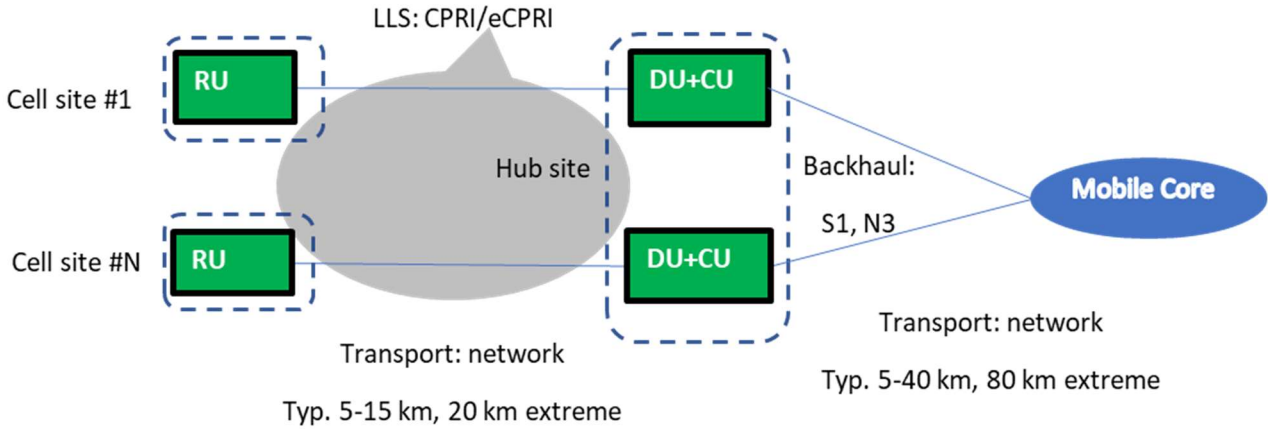

Figure 5: CRAN architecture. The LLS links are highlighted by the gray oval.

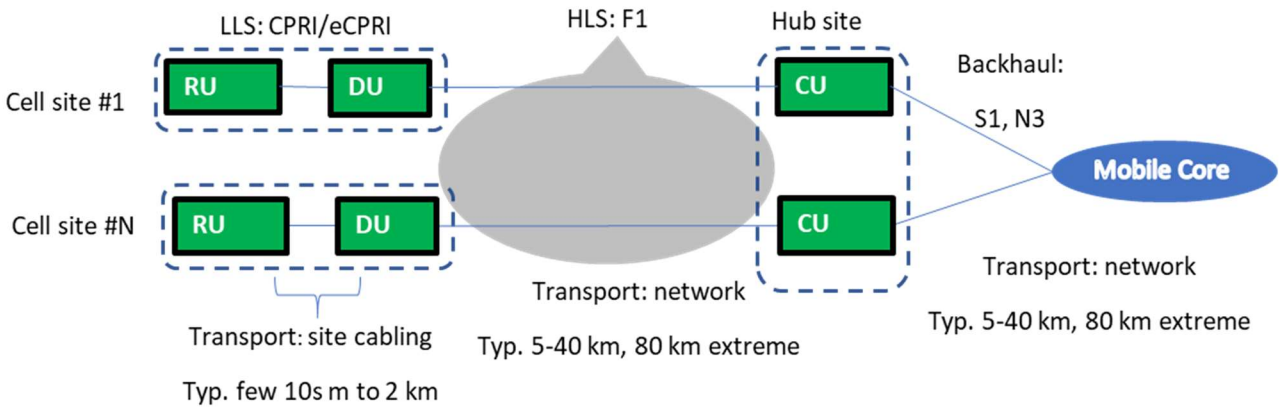

Figure 6: Virtual RAN architecture. The HLS links are highlighted by the gray oval.

6. Generic optical solutions requirements in mobile transport networks

The purpose of this section is to outline the specific requirements characterizing “radio-grade” optical solutions.

6.1. Operating temperature and power consumption classes

In mobile transport networks, optical pluggable modules can be used in RUs or packet nodes that are located outdoors, which requires a wide operating temperature range. While DUs may be deployed in temperature-controlled locations, especially for CRAN, it might be beneficial from an inventory, planning and testing perspective to use wide temperature optical pluggable modules also for DUs. Using wide temperature optics for indoor applications can add cost at the initial phases of the technology and product life cycle, but history and consolidated trends in the industry indicate that this cost addition disappears over time.

The typical requirement for outdoor-grade optical pluggables is the so-called “industrial case operating temperature range”, or “I-temp” for short, ranging from -40 °C to 85 °C. It is identified that a lower bound of -20 °C could provide cost advantages in certain scenarios: the definition of such scenarios and the intended transceiver behavior between -40°C and -20°C case temperature is for further study.

For certain applications with a high density of dissipated power, it could also be necessary to exceed the upper temperature limit, which may require alternative solutions. In this paper, we assume I-temp for all pluggables unless otherwise stated.

Following the methodology described in [OIF-Thermal], we can use the following power consumption classes (PC) which should not be exceeded to facilitate implementation and thermal management on host units.

Form factor	PC 1 [W]	PC 2 [W]	PC 3 [W]	PC 4 [W]	PC 5 [W]	PC 6 [W]
SFP+/28	1	1.5	2.0	2.5	-	-
DSFP/SFP-DD	1	1.5	2.0	2.5	-	-
SFP56	1	1.5	2.0	2.5	-	-
QSFP28	1.5	2.0	2.5	3.5	4.0	4.5 ⁵
QSFP-DD	1.5	3.5	7.0	8.0	10	12

Table 2: Power consumption classes (PC) for pluggables, using the methodology in [OIF-Thermal].

The values and classes of Table 2 will be used for the Blueprints outlined in this paper.

Apart from thermal aspects, it’s important not to exceed these values because they are used to dimension the electrical power supply of the host boards.

⁵ BiDi DWDM QSFP28 can have up to 7W power consumption

6.2. EMI and EMC

EMI and EMC requirements at module level are particularly important, given the possible proximity of optical pluggables to RF receivers: in order to provide enough margin for system-level tests, it's not uncommon to require figures of 6 dB to 12 dB better than the applicable transceiver-level standards in [ETS-EMC] and [FCC15].

6.3. Latency

Particular care must be taken to limit the worst-case latency introduced by the optical pluggable (due to DSP, serialization, FEC encoding and decoding, possibly other manipulations like interleaving). As a general criterion, a contribution to single-ended latency in the order of a few μ s can be tolerated.

6.4. Synchronization

It is also important that potential sources of PTP timestamping inaccuracy are tightly controlled. Any effect, deterministic or stochastic, potentially leading to uplink/downlink propagation delay asymmetry, directly impacts the time error budget. The acceptable contribution of pluggables in point-to-point links to overall uplink/downlink delay asymmetry should be less than a few ns. For TDM-PON systems the delay is inherently asymmetric, and this is circumvented by a termination of PTP at the OLT, the use of TPS-TC (Transport Protocol Specific – Transmission Convergence), and generation of PTP at the ONU side.

6.5. Support of multiple bit rates

The specific nominal bit rates which must be supported are part of the detailed Blueprints descriptions. In general terms, transceivers using internal re-timer ICs are expected to support “re-timer bypass” functions, to allow operation at lower bit rates.

6.6. Form factor standards

The aforementioned form factors are expected to be fully compliant with the relevant SFF MSA specifications in Table 3.

Name	Main specification	Low-speed and general electric specification	High-speed electric specification	Common management specification
SFP+	SFF-8083	SFF-8419	SFF-8418	SFF-8472
SFP28	SFF-8402	SFF-8419	CEI-28G-VSR, IEEE 802.3, 109B.3.2,4	SFF-8472
SFP56	SFF-8402	SFF-8419	CEI-56G-VSR, IEEE 802.3, 135G.3.2,4	SFF-8472
DSFP	DSFP MSA		CEI-28G-VSR	ACMIS (abridged CMIS)
QSFP28	SFF-8665	SFF-8679	CEI-28G VSR, IEEE 802.3 83E.3.2,4	SFF-8636
QSFP-DD	QSFP-DD MSA		CEI-56G VSR, IEEE 802.3 120E.3.2,4	CMIS (common management interface spec)

Table 3: Pluggable form factors and their standards.

The so-called *digital diagnostic monitoring* (DDM) in SFF-8472 and SFF-8636 is very important for observability of optical links, and the *internally calibrated* approach is nowadays almost ubiquitous in line card implementations. No standards exist today for *remote* DDM, i.e., the possibility to access the DDM of a remote transceiver using the management interface of a local transceiver, using an out-of-band, low bit rate auxiliary communication channel.

6.7. Connectors: UPC, APC

Solutions must be able to work on outdoor fiber plants based on UPC/LC single mode connectors: thus, they must be able to tolerate a maximum discrete optical return loss of -50 dB⁶ [IEC61753]. The only exception to this rule is represented by PON solutions, which can also be based on APC/LC single mode connectors in some cases. Unless stated otherwise inside the detailed Blueprints description, UPC/LC single mode connectors must be assumed.

6.8. Tunable and automatic self-tunable DWDM pluggables

Currently, 10 Gb/s DWDM networks are utilizing either fixed wavelength or wavelength tunable transceivers. It is highly desirable that all DWDM applications described in this document rely on tunable transceivers, for inventory simplification and consequent reduction of the operational costs (no need to label or track fibers, only a single part number is required instead of 48⁷ or 96, easier forecasting and inventory management, less potential for stranded inventory at unused wavelengths). Sub-optimal solutions, where the transceiver can only tune over a subset of wavelengths, can be acceptable as temporary solutions, if the cost gap between full-tunable transceivers and fixed wavelength transceivers remains too big.

Self-tunable transceivers add the capability to automatically set the transmission wavelength (*self-tune*) leading to further simplification of network installation and operation practices. This is usually achieved by means of a negotiation procedure between the transceivers at the two ends of the link, exploiting information conveyed through a signaling channel, which can be either in band prior to the start of traffic (e.g., using the same transmission protocol and frame of traffic data) or out of band (e.g., superimposing to the modulating signal an additional amplitude modulation at a low bit rate and low modulation depth). Both solutions have the advantage of being agnostic to the protocol used for transmitting the data (e.g., Ethernet or OTN).

Although customers understand the significant benefits of the self-tune feature, cross-brand units will not interoperate properly due to the proprietary Self-Tuning Optic (STO) schemes which have been designed and implemented by the various transceiver suppliers. Due to the increasing interest in these features, it is important to identify requirements and propose multi-vendor interoperable solutions for standardization.

An MSA for STO functionally has been made [SmartT] that enables reduction in OpEx and CapEx:

- Plug and Play feature means less technician time in the field.
 - No need to label or track fibers and no need to buy hundreds of tuning boxes to set the wavelength.
- Only 1 part number is required instead of 96.
 - Easier forecasting and inventory management.
 - Reduces the potential for stranded inventory at the wrong/unused wavelengths.

The self-tuning functionality will not require anything new from the host system and the host system can enable or disable this function.

6.9. Loss budget (channel insertion loss) and chromatic dispersion

In this document we focus on single-mode fiber. Comparing with multi-mode fiber, single-mode fiber has clear advantages for the outside plant fiber with its much higher bandwidth-distance

⁶ It should be pointed out however, that such low values are difficult to assure in field environments, where return loss values of -35 dB are more realistic.

⁷ Used in this paper, reference [G.698.2] specifies a 48 channel 100 GHz grid with min central frequency of 191.5 THz, and max central frequency of 196.2 THz

product, better tolerance to fiber bends, and lower cable cost. Pluggables for multi-mode fiber can be lower cost than corresponding for single-mode fiber, but that cost has historically been shown to diminish/vanish with volume. Moreover, I-temp tend to be challenging for low-cost multi-mode transmitters. Multi-mode can be interesting for short distance temperature-controlled data center environments. i.e., when using short patch-cords and active cables.

There are many standards for loss budgets, also called channel insertion loss, used in standards documents and the industry. Examples for cabled fiber and splice attenuation include:

- ITU-T G.652 Table I.1: Cabled concatenated links incl splices: 0.5 dB/km @ 1.3 um, 0.275 dB/km @ 1.55um.
- Commercial example for SMF-28: max 0.35 dB/km 1285-1330nm, max 0.20 dB/km @ 1550 nm (excl. splices).
- ITU-T G.671: Fusion splice active alignment: 0.3 dB.
- ITU-T G.sup39: Cables installed after 2003, Fiber att. average 0.349 dB/km @ 1.3um, 0.205 dB/km @ 1.55um (incl. splices every 2 km).

For connectors (typ. LC assumed in this paper), examples include:

- ITU-T G.671: max 0.5 dB 1260-1360 nm.
- Commercial products: 0.25 - 0.5 dB.

The values above will in many cases over-engineer the optics, leading to higher component costs than necessary. Instead, this paper suggests a pragmatic approach to find a balance between high quality/reasonable margin and cost: 0.4 dB/km @ 1.3um, 0.25 dB/km @ 1.55um, connector losses of 0.5 dB.

We assume that there are up to four intermediate connector jumps for distances up to 20 km. For 40 km, since such long links may pass additional flexibility points, we assume up to six connector jumps.

In addition, it is customary for operators to allocate a small margin for maintenance reasons (e.g., degradation of fiber, new splices, bad connectors or minor fiber bends). Consequently, the following loss budget values will be used in this paper:

Distance	Fiber attenuation @ 1.3 um	Fiber attenuation @ 1.55 um	Connectors Insertion Loss	Maintenance Margin	Total Loss budget - P2P fiber @ 1.3 mm	Total Loss budget - P2P fiber @ 1.55 mm
≤ 2 km	0.8 dB	0.5 dB	2 dB (4x)	0 dB	2.8 dB	2.5 dB
10 km	4 dB	2.5 dB	2 dB (4x)	1 dB	7.0 dB	5.5 dB
15 km	6 dB	3.8 dB	2 dB (4x)	1 dB	9.0 dB	6.8 dB
20 km	8 dB	5 dB	2 dB (4x)	1 dB	11.0 dB	8.0 dB
40 km	16 dB	10 dB	3 dB (6x)	2 dB	21.0 dB	15.0 dB

Table 4: Loss budget values used in this paper. The total loss budget is sometimes called Channel insertion loss.

It should be noted that the above values do not take into account the transmitter and dispersion penalties etc., which have to come on top of the loss values for a complete power budget

specification. Thus, this paper does not deal with power budget specifications and the related transmitter and receiver requirements.

It should be noted that the above total loss values are higher than those for IEEE 10GBASE-ER, 25GBASE-ER and 4WDM-40.

For 10G, we assume a BER of $10e-12$, while for 25G and 100G we assume a BER $5e-5$. The latter assumes using FEC with RS(528, 514), i.e., the so-called “KR” FEC. The FEC functionality is implemented in the host system, not in the pluggable.

In some cases, a wavelength mux is required. Commercial values for the insertion loss vary in the range of 4.6 to 6.0 dB depending on the type (AWG vs TFF) and the design. For networks that employ a point-to-multipoint fiber infrastructure with passive power-splitting, i.e., a TDM-PON fiber network, the insertion loss of splitters must be added to the insertion loss values indicated for P2P fiber in Table 4.

Nominal wavelength mux and power splitter insertion losses are shown in the table below:

Component	CWDM Mux DeMux 6ch (TFF), Pair	DWDM Mux DeMux 48 ch (AWG), Unit	DWDM fixed OADM 6 ch (TFF) Pass / AddDrop, Unit	Power splitter 1:2	Power splitter 1:4	Power splitter 1:8	Power splitter 1:16	Power splitter 1:32	Power splitter 1:64
Insertion loss [dB]	4.5	5.5	0.6 / 3.0	3.5	7	10.4	13.9	17.4	21

Table 5: Insertion loss values for passive optical components used in this paper.

With a similar line of thinking, the value for Chromatic Dispersion (CD) used in this paper is 18 ps/(nm*km) for the C-band and 4 ps/(nm*km) for the O-band. An appropriate Optical Path Penalty (OPP) must be included in the network design to account for the impairments over a fiber distance taken together with any CD mitigation capabilities.

6.10. Lifespan of optical pluggables

Whatever the functional split and the architecture, antenna sites in RAN will remain geographically scattered as they must ensure the intended radio layer coverage. The number of antenna sites and their variety are very large: some antenna sites can be quite difficult and expensive to access, for instance tall cell towers. Geographical distribution of antenna sites also makes spare parts management and logistics an important operational cost. Therefore, lifespan and reliability of optical transceivers for RAN cannot be relaxed to a point they adversely impact whole network operation costs.

The lifetime of optical transceivers, defined as the period of time for which all requirements must be fulfilled, must be at least 15 years.

During the lifetime, it is also very important that the number of random failures expressed in FITs (number of failures per billion device hours) at high case operating temperature is very low. If converted from FITs to MTBF and expressed in years, the typical reliability figure required at high case temperature is normally *one order of magnitude larger* than the ‘lifetime’ figure.

7. Mobile Optical Solution Blueprints for LLS in Distributed RAN (DRAN)

7.1. Overview

DRAN is the original RAN deployment and is the most popular deployment method where the DU and RU are in proximity, often within a cell site. The figure below illustrates a simplified DRAN architecture.

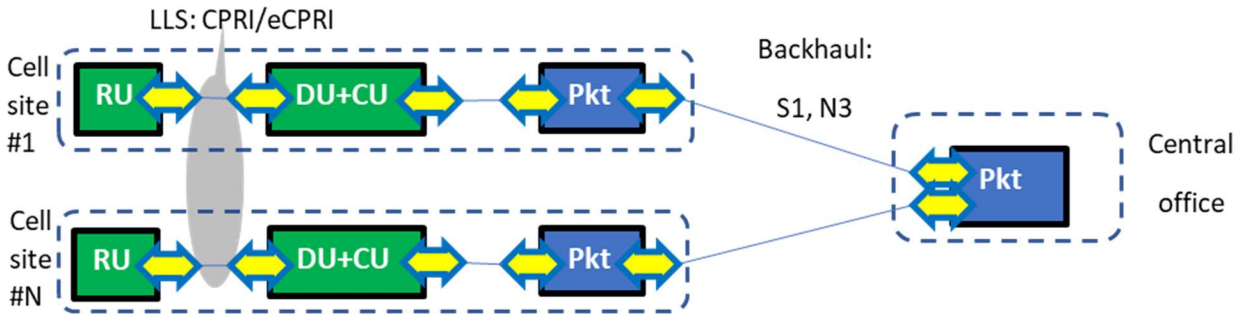

Figure 7: DRAN architecture with RAN nodes, transport nodes and optical pluggables.

Following the above, most of the DRAN DU-RU links are less than 300 m, with significant tails up to a few kilometers, as shown in the picture below.

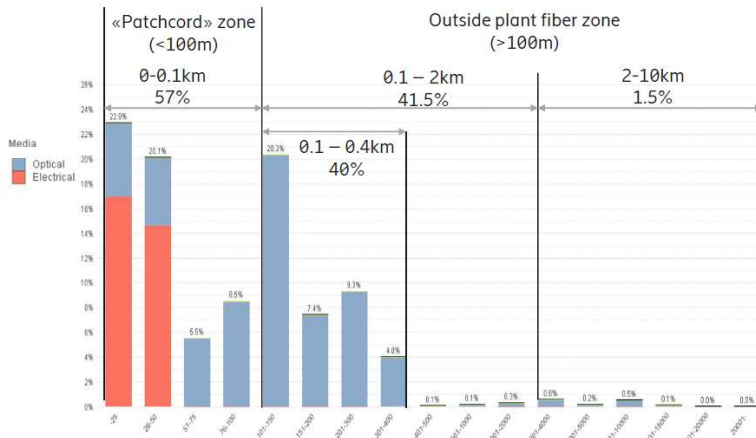

Figure 8: DRAN LLS link length distribution.

(source: Ericsson, by characterizing millions of DRAN LLS links in live networks).

The typical rooftop installation for macro base stations consists of three radios, with three antennas covering a 120° sector each, to provide omni-directional coverage. This structure is replicated on the same site when several frequency bands have to be supported: for instance, in 4G/LTE a typical deployment is 3x2 (three sectors, two frequency bands). Thus, the number of RU pluggables required at a cell site tends to be a multiple of 3 or 6, with the same for the number of fibers or WDM channels (when used). For 4G/LTE-E deployments, considering typical radio configurations and capacities, the required LLS capacity per sector usually does not exceed 10 Gb/s.

© 2022 Ericsson, Nokia, II-VI, Lumentum and Sumitomo Electric.

This document may be freely reproduced and distributed whole and intact including this Copyright Notice."

With the adoption of 5G, capacity requirements have increased but the rearchitecting of the radio base stations has exposed more bandwidth-efficient LLS transport interfaces, thus limiting the potential explosion of capacity. For 5G NR deployments, considering early radio configurations and capacities, the required LLS capacity per sector usually does not exceed 25 Gb/s today but the adoption of AAS and higher frequency bands will push the required LLS capacity further [GSTR-TN5G].

The two typical scenarios of fiber resources availability in DRAN are reported below:

In the majority of cases, DUs (or DU+CU) are located in close proximity of the RUs (cell towers or rooftop installations) and the fiber interconnect length is relatively short, in the order of few hundred meters: in this scenario not only is the fiber an abundant resource: it is often considered a *consumable* (patch-cords) part of a site cabling solution. Duplex fiber short reach pluggables, which are very cost-effective, can be used.

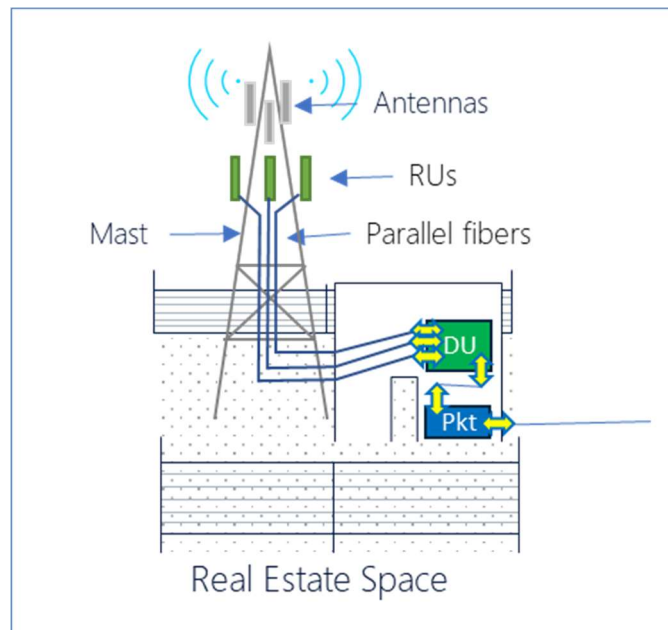

Figure 9: Cell site illustration for the DRAN fiber abundance case.

There are other cases in which the DUs (or DU+CU) and the RUs are not co-located due to for example real estate constraints⁸. In these cases, optical patch-cords cannot be used, and dark fiber (typically part of a large cable running in an underground duct) must be used instead. In this case, it may be beneficial to deploy single-fiber BiDi pluggables, allowing to use/lease a single dark fiber strand instead of two.

For DRAN deployments, considering the short distance, it is relatively uncommon to find scenarios with a lack of fiber resources.

⁸ One common example is when the DUs are located in the basement of a building and the RUs on the rooftop of another building, one or more blocks away.

10 km is traditionally considered the *shortest distance of interest* for transport networks. However, as is evident from Figure 8, the fiber distances in DRAN deployments are typically much shorter. Reducing the reach requirements may allow to reduce costs by using inherently cheaper laser sources. This happened for instance with Fabry-Pérot (FP) lasers, creating in LLS the typical “up to 2 km” solution space also seen in ITU-T specs for intra-office and IEEE802.3 for data center inter-connects.

Scenarios requiring 10G BiDi are currently covered with 15 km-capable lasers due to the lack of suitable Fabry-Pérot laser couples with the proper wavelengths (B2: 1270 nm, 1330 nm). Reach-reduced BiDi pluggables at 25 Gb/s can be supported by reusing the DFB laser couples, with the proper wavelengths (B2: 1270 nm, 1330 nm), currently in use for 15 km 10 Gb/s BiDi, trading fiber reach for extra penalties introduced by the higher speed modulation.

7.2. DRAN Optical Blueprints

7.2.1. 2 km RU-DU direct parallel fibers, dual and BiDi fiber Blueprint

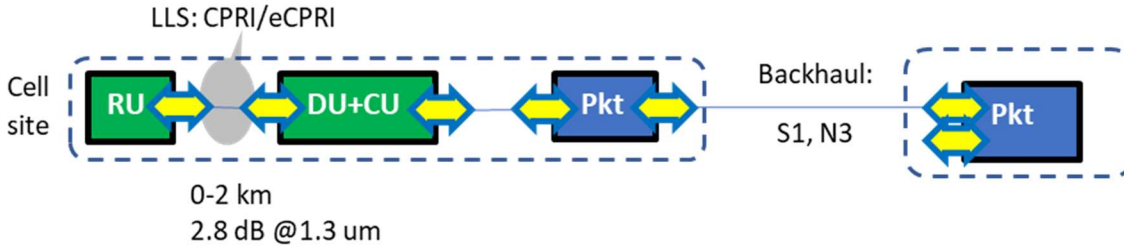

Figure 10: 2 km RU-DU direct parallel fibers Blueprint.

2 km RU-DU Direct parallel fibers Blueprint			
Typical use cases	DRAN DU to RU; DU to cell site router intra-site; DU and/or cell site router to microwave element intra-site. Up to 2 km		
Distance	Typ Min 0 km; Typ. Max: 2 km		
Channel Insertion Loss	2.8 dB @1.3 um (For Typical Max Distance)		
Mode, Nr ch., Wavelengths	Dual fiber: O-band 1310 nm. BiDi O-band 1270nm/1330 nm.		
Temp. Range/Class	I-temp		
Lifespan	15 years		
Data rates	10 Gb/s	25 Gb/s	50 Gb/s
Formfactor	SFP+	SFP28	SFP56
FEC, Mod. format	No, NRZ	Yes, NRZ	Yes, PAM4
Power Class	PC2 (1.5 W)	PC2 (1.5 W)	PC2 (1.5 W)
Pluggables codes	10G-2km-O-G-1-2-SFP+ 10G-2km-O-B2-2-1-SFP+	25G-2km-O-G-1-2-SFP28 25G-2km-O-B2-2-1-SFP28	50G-2km-O-G-1-2-SFP56 50G-2km-O-B2-2-1-SFP56
Key technologies	-	Low-cost 25G DFB (e.g., reuse 10G 10 km). New low-cost tech like 25G FP.	TBD
Standards	Phy: Dual fiber: IEEE 802.3, Clause 52 (10GBASE-L). Bidi: IEEE 802.3, Clause 158 (10GBASE-BR10) (**)	Phy: Dual fiber: IEEE 802.3, Clause 114 (25GBASE-LR). Bidi: IEEE 802.3, Clause 159 (25GBASE-BR10) (**)	Phy: Dual Fiber: IEEE802.3, Clause 139 (50GBASE FR). Bidi: IEEE 802.3, Clause 160 (50GBASE-BR10) (**)
Market status and outlook (*)	Mature	Ramping, complement to 10G	Introduced, complement to 25G

Table 6: 2 km RU-DU direct parallel fibers Blueprint. (*) Following Figure 8, distances up to 2 km are expected to cover a large majority of the deployments. (**) The current standard covers up to 10 km, but may not be cost optimized for 2 km.

7.2.2. 10 km RU-DU direct parallel fibers, dual and BiDi fiber Blueprint

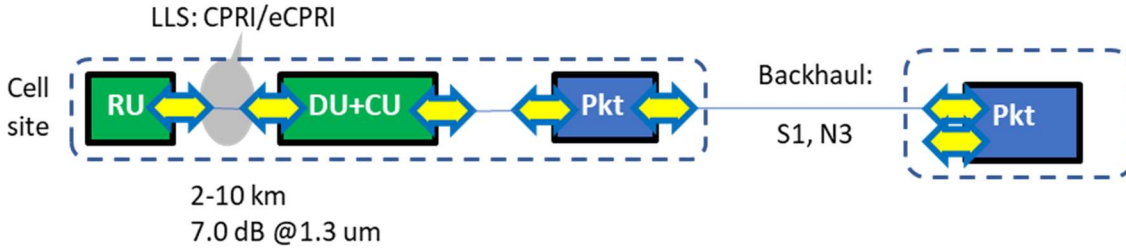

Figure 11: 10 km RU-DU direct parallel fibers Blueprint.

10 km RU DU Direct parallel fibers Blueprint			
Typical use cases	DRAN DU to RU. 2-10 km		
Distance	Typ. Min 2 km; Typ. Max: 10 km		
Channel Insertion Loss	7.0 dB @1.3 um (For Typ. Max Distance)		
Mode, Nr ch., Wavelengths	Dual fiber: O-band 1310 nm. BiDi O-band 1270nm/1330 nm.		
Temp. Range/Class	I-temp		
Lifespan	15 years		
Data rates	10 Gb/s	25 Gb/s	50 Gb/s
Formfactor	SFP+	SFP28	SFP56
FEC, Mod format	No, NRZ	Yes, NRZ	Yes, PAM4
Power Class	PC2 (1.5 W)	PC2 (1.5 W)	PC2 (1.5 W)
Pluggables codes	10G-10km-O-G-1-2-SFP+ 10G-10km-O-B2-2-1-SFP+	25G-10km-O-G-1-2-SFP28 25G-10km-O-B2-2-1-SFP28	50G-10km-O-G-1-2-SFP56 50G-10km-O-B2-2-1-SFP56
Key technologies	-	Low-cost 25G DFB	TBD
Standards	Phy: Dual fiber: IEEE 802.3, Clause 52 (10GBASE-L, except for 6.2 vs. 7.0 dB IL), Bidi: IEEE 802.3, Clause 158 (10GBASE-BR10, except 6.2 vs. 7.0 dB IL, or 10GBASE-BR20)	Phy: Dual fiber: IEEE 802.3, Clause 114 (25GBASE-LR, except 6.3 vs. 7.0 dB IL) Bidi: IEEE 802.3, Clause 159 (25GBASE-BR10, except 6.3 vs. 7.0 dB IL, or 25GBASE-BR20, except wavelength range)	Phy: Dual Fiber: IEEE802.3, Clause 139 (50GBASE-LR). Bidi: IEEE 802.3, Clause 160 (50GBASE-BR10)
Market status and outlook	Mature	Ramping, complement to 10G	Introduced, complement to 25G

Table 7: 10 km RU-DU direct parallel fibers Blueprint. (*) For DRAN, distances between 2 and 10 km are expected to be much fewer than those ≤ 2km.

8. Mobile Optical Solution Blueprints for LLS in Centralized RAN (CRAN)

8.1. Overview

Centralization of DUs to a single common location drives the need to cover longer fiber distances to connect with the RUs: typical values span for a few kilometers up to 20 km. Specifically, the majority of cases will be below 10 km, almost all below 15 km, and very few cases up to 20 km.

Figure 12 depicts the centralization of the DU and optionally the CU to a hub site. It should be noted that there are three conceivable categories of solutions involving the presence/absence of transport equipment at each end. These are:

1. Active-Active: there is transport equipment at both ends (e.g., Cell site #1)
2. Semi-Active: there is transport equipment only at the hub location. At the cell site, the optical module is plugged directly into the RU (e.g., Cell site #2)
3. Passive-Passive: there is no transport equipment. The optical modules are plugged directly into the RAN equipment at both extremity (e.g., Cell site #3)

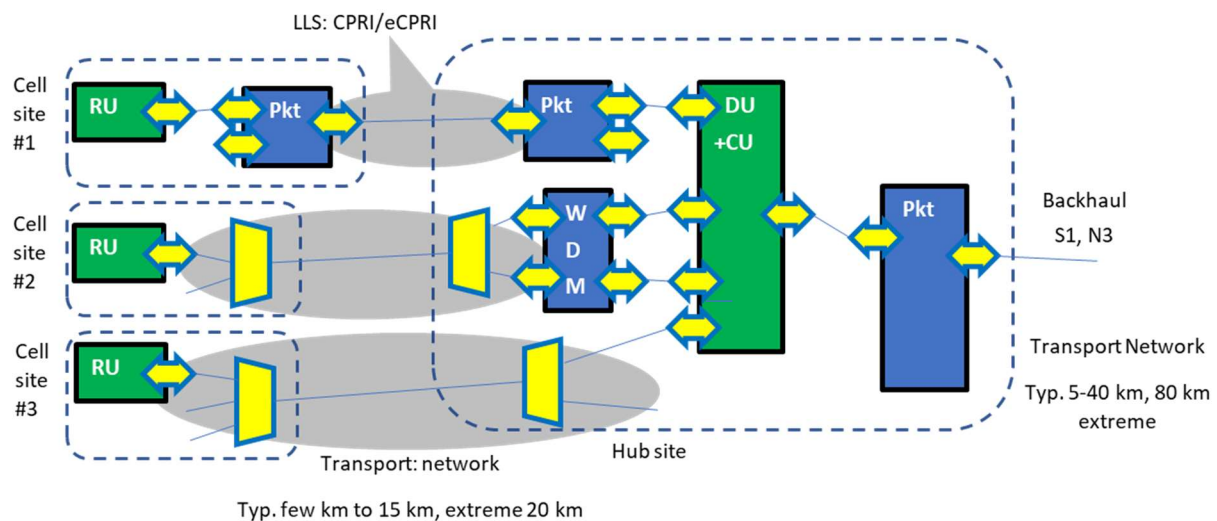

Figure 12: CRAN architecture with RAN nodes, transport nodes and optical pluggables. Cell site #1 shows a case with packet aggregation, Cell site #2 shows a case with semi-active WDM, and Cell site #3 shows a case with passive WDM aggregation.

In CRAN, the site cabling scenario (described for DRAN), which can be solved with optical patch-cords, is clearly not applicable: instead, an installed fiber plant must be used. Availability of fibers varies greatly with the region and the local policies and market regulations.

There are scenarios in which fiber can be considered a relatively abundant resource, for example, in cases where the network operator also owns fiber assets, or because the cost for leasing fiber resources from third parties is relatively low. In other scenarios, typically in dense urban areas and in unregulated markets, fiber is a scarce resource with high value: its lease costs can be high, driving fiber-lean solutions.

Duplex fiber solutions are used in the fiber abundance cases and when the cost of fiber is low. However, in many cases it is very attractive to use optical BiDi pluggables to reduce the number of fibers by two vs dual fiber pluggables.

Another way of effective use of fiber resources is by using WDM technologies. Comparing the laser cost of an 18-wavelength CWDM system to that of a 48-wavelength DWDM system, both for 10 Gb/s and 15 km reach, comes out to about the same for both systems since they use similar cooled EML transmitters. Thus, the DWDM system is a better choice for scalability reasons. Inherently cheaper, cooled DFB, directly modulated lasers can be used for CWDM, but only for the six wavelengths close to the zero dispersion of fiber (1310 nm). If six wavelengths/ three bidirectional links over a single fiber are enough, CWDM can be a cost-effective alternative. Such cost-effective CWDM solutions can currently offer a reach of about 10 km, so while the sweet spot is 15 km reach, it is not clear whether this technology should be improved in reach as this would potentially lead to higher cost.

There are, conceptually, two flavors of WDM transport, one that uses a wavelength mux as the branching node in the field and one that uses a power splitter in the field [G989].

- WR-WDM: the first is the more prominent solution and is referred to as Wavelength Routed (WR) since the downstream wavelengths are routed by the wavelength mux at the branching node. There are a number of standardization efforts for this generic architecture (e.g., ORAN, ITU-T SG15 Q6 and ITU-T SG15 Q2 [G.989.x] and [G.9802.x]). Blueprints for this option are presented in Sections 8 and 9.
- WS-WDM: the second is being explored by some operators and is referred to as a Wavelength Selected (WS) because the desired downstream wavelength must be selected by the end node from among all the wavelengths arriving at that point. Some standardization work has been done on this architecture by ITU-T SG15 Q2 [G989] but it is not a mainstream solution at this point. The option will be described in section 12 as a solution that is under evaluation for the future.

NOTE: In some circles, the term PON (Passive Optical Network) is used to describe any point to multi-point architecture that involves a passive branching node, whether that is a Wavelength MUX or a Power Splitter. TDM-PON is the most common form of PON but it is not the only type of PON. There can also be TWDM-PON and WDM-PON in which the users share a time slot, a wavelength or a combination of the two. Under this definition, the above two architectures would be referred to as a WR-WDM-PON and a WS-WDM-PON. These terms are commonly used in fiber access circles but not necessarily elsewhere, so this note is for background information.

A final observation should be made regarding the architectures that use WDM. In fact, the branching node (whether Wavelength Mux or Power Splitter) can be located at either the cell site or at some other location in the fiber access outside plant. Both alternatives are possible, even though the illustrations may show one location or the other. The location does not affect the functionality.

Packet aggregation enables using high-speed gray optics to reduce the fiber count. Single fiber BiDi high bit rate interfaces couldn't be designed in a cheap and simple way in the era of 4x25 Gb/s-based 100 Gb/s implementation, but the rise of single lambda 100 Gb/s solutions paved the way for simple BiDi (e.g., 1270 nm/1310 nm) single fiber implementations.

The combination of high bit rates and wavelength division multiplexing provides a route to scale capacity, for cases where it is not possible to meet the requirement on the number of fiber resources with BiDi optics. Coherent pluggables are today not cost-optimized for use in CRAN, but direct-detect alternatives are few and their limited performance is placing more demands on the optical infrastructure: the definition of cost reduction opportunities for coherent pluggables should be addressed by new industrial agreements. The same 100G+ bit rate solutions will of course also be useful to support future further capacity growth in DRAN.

8.2. CRAN Optical Blueprints

8.2.1. 15 km RU – DU direct parallel fibers, dual and BiDi fiber Blueprint

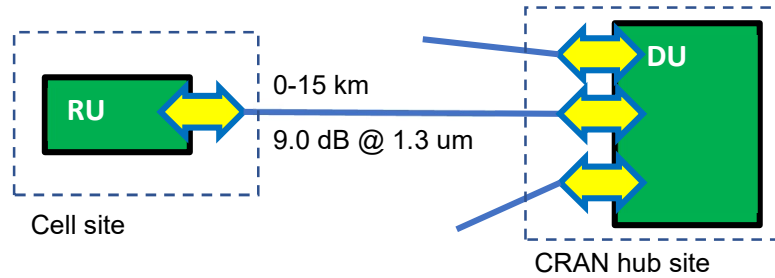

Figure 13: 15 km RU-DU direct parallel fibers Blueprint.

15 km RU DU Direct parallel fibers Blueprint			
Typical use cases	CRAN DU to RU		
Distance	Typ Min 0 km; Typ. Max: 15 km		
Channel Insertion Loss	9.0 dB @1.3 um (For Typ. Max Distance)		
Mode, Nr ch., Wavelengths	Dual fiber: O-band 1310 nm. BiDi O-band 1270nm/1330 nm.		
Temp. Range/Class	I-temp		
Lifespan	15 years		
Data rates	10 Gb/s	25 Gb/s	50 Gb/s
Formfactor	SFP+	SFP28	SFP56
FEC, Mod. format	No, NRZ	Yes, NRZ	Yes, PAM4
Power Class	PC2 (1.5 W)	PC2 (1.5 W)	PC2 (1.5 W)
Pluggables codes	10G-15km-O-G-1-2-SFP+ 10G-15km-O-B2-2-1-SFP+	25G-15km-O-G-1-2-SFP28 25G-15km-O-B2-2-1-SFP28	50G-15km-O-G-1-2-SFP56 50G-15-B2-2-1-SFP56
Key technologies	-	Low-cost 25G DFB	TBD
Standards	Phy: Dual fiber: No (**) Bidi: IEEE 802.3, Clause 158 (10GBASE-BR20)	Phy: Dual fiber: No (**) Bidi: IEEE 802.3, Clause 159 (25GBASE-BR20, except wavelength range)	Phy: Dual fiber: No. (**) Bidi: IEEE802.3, Clause 160, (50GBASE-BR20, except wavelength range)
Market status and outlook (*)	Mature	Ramping, complement to 10G	Introduced, complement to 25G

Table 8: 15 km RU-DU direct parallel fibers Blueprint. (*) For CRAN, the fiber abundance case is a medium size market. (**) ER (40 km) could be used while significantly over specified.

8.2.2. 10 km RU – DU, passive CWDM over a single fiber Blueprint

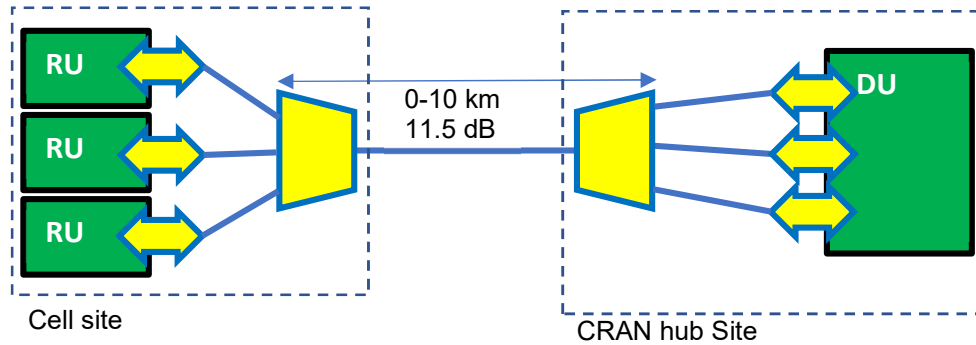

Figure 14: 10 km RU-DU CWDM passive wavelength multiplexed, P2P or P2MP Blueprint.

10 km RU-DU CWDM Blueprint		
Typical use cases	CRAN DU to RU. Up to 10 km CWDM P2P or P2MP links up to 3 SFP+ pairs using the same single trunk fiber	
Distance	Typ Min 0 km; Typ. Max: 10 km	
Channel Insertion Loss	7.0 dB @1310 nm for the fiber (For Typ. Max Dist.), 4.5 dB per WDM mux/demux pair, total 11.5 dB	
Mode, Nr ch., Wavelengths	Dual fiber pluggables, single fiber trunk: Wavelength pairs (DU/RU): 1271/1291, 1311/1331, 1351/1371 nm (i.e. the six shortest wavelengths from [G.694.2])	
Temp. Range/Class	I-temp	
Lifespan	15 years	
Data rates	10 Gb/s	25 Gb/s
Formfactor	SFP+	-
FEC. Mod format	No, NRZ	TBD
Power Class	PC3 (2.0 W)	
Pluggables codes	10G-10km-*-C-6-2-SFP+	
Key technologies	-	
Standards	Phy: ITU-T G.695	-
Market status and outlook (*)	Mature	For 25G, the global market demand is not concluded at this point.

Table 9: 10 km RU-DU CWDM Blueprint. (*) The global market outlook for CWDM is not clear at this point.

8.2.3. 15 km RU-DU, passive DWDM over a single fiber Blueprint

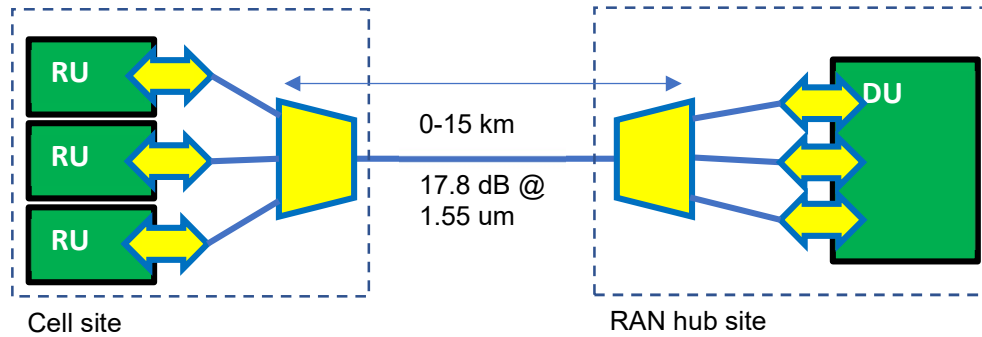

Figure 15: 15 km RU-DU, DWDM passive wavelength multiplexed, P2P or P2MP Blueprint.

15 km RU-DU DWDM Blueprint		
Typical use cases	CRAN DU to RU. Up to 15 km DWDM P2P (all RUs at the same location together with the optical multiplexer) or P2MP (the RUs are located in slightly different locations, with the optical multiplexer at one of those, or another location) links up to 24 SFP+ pairs using the same single trunk fiber.	
Distance	Typ Min 0 km; Typ. Max: 15 km	
Channel Insertion Loss	6.8 dB @1.55 um for the fiber (for Typ. Max Dist.), 5.5 dB per WDM mux, total 17.8 dB	
Chromatic Dispersion	270 ps/nm	
Mode, Nr ch., Wavelengths	Dual fiber pluggables, single fiber trunk: 48 wavelengths @ 0.8nm/100GHz spacing	
Temp. Range/Class	I-temp	
Lifespan	15 years	
Data rates	10 Gb/s	25 Gb/s
Formfactor	SFP+	SFP28
FEC, Mod format	No, NRZ	Yes, NRZ
Power Class	PC4 (2.5 W)	PC4 (2.5 W)
Pluggables codes	10G-15km-C-D-48-2-SFP+	25G-15km-C-D-48-2-SFP28
Key technologies	Low-cost EML DWDM, without wavelength lockers. Athermal AWG and TFF filters	
Standards	Phy: ITU-T G.698.1, Table 8.3, NRZ 10G 100 GHz spacing short-haul (except for relaxed chromatic dispersion)	Phy: No
Market status and outlook (*)	Mature	25G: emerging, expected to complement 10G over time

Table 10: 15 km RU-DU DWDM Blueprint. (*) Using DWDM to solve fiber scarcity for CRAN is common. Higher rates are not expected before 2023.

8.2.4. 15 km RU-DU, passive DWDM bus over a single fiber Blueprint

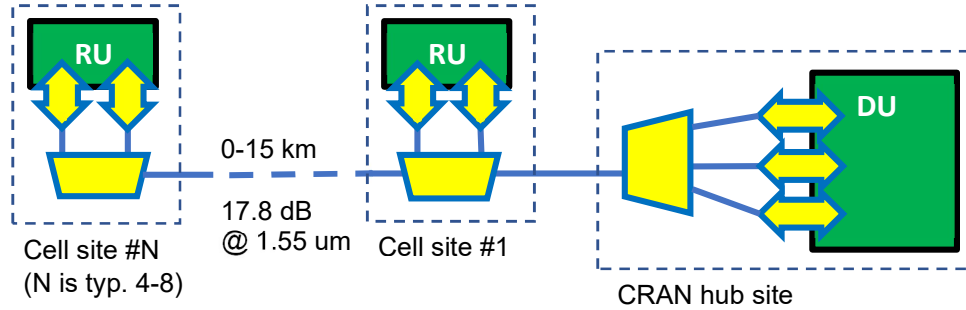

Figure 16: 15 km RU-DU, DWDM passive wavelength multiplexed bus Blueprint.

15 km RU-DU DWDM bus Blueprint		
Typical use cases	CRAN DU to radio unit (RU). Up to 15 km DWDM bus or horseshoe topologies with one headend at DU side and multiple add/drop RU sites. Links up to 24 SFP+ pairs using the same single trunk fiber.	
	<ul style="list-style-type: none"> - Flexible use of the available loss budget up to 17.8 dB. (*) - Max number of added/dropped channel at each OADM: 6 - Number of OADMs : Up to 8. (**) 	
Distance	Typ Min 0 km; Typ. Max: 15 km	
Channel Insertion Loss	Max 17.8 dB to use for the fiber (max 6.8 dB @1.55 um), 0.6 dB per OADM pass and 3.0 dB for add/drop (up to 8 OADMs (**)).	
Chromatic Dispersion	270 ps/nm	
Mode, Nr ch., Wavelengths	Dual fiber pluggables, single fiber trunk between MUX and OADM: 48 wavelengths @ 0.8nm/100GHz spacing.	
Temp. Range/Class	I-temp	
Lifespan	15 years	
Data rates	10 Gb/s	25 Gb/s
Formfactor	SFP+	SFP28
FEC	No	Yes
Power Class	PC4 (2.5 W)	PC4 (2.5 W)
Pluggables codes	10G-15km-C-D-48-2-SFP+	25G-15km-C-D-48-2-SFP28
Key technologies	Low-cost EML DWDM, without wavelength lockers. Athermal AWG and OADM TFF filters.	
Standards	Phy: ITU-T G.698.1, Table 8.3, NRZ 10G 100 GHz spacing short-haul (except for relaxed chromatic dispersion)	Phy: No
Market status and outlook (***)	Mature	25G: emerging, expected to complement 10G over time.

Table 11: 15 km RU-DU DWDM bus Blueprint. (*) The 17.8 dB value comes from the 8.2.3 Blueprint. Flexible use means that the total loss budget is not calculated as a sum of the fiber and filters losses, but specified as a system limit, that a system design can use a combination of fiber and filter losses up to that value. (**) Typical no. of OADMs are 4-6, with cases of 7-8 are expected to be few. (***) Using DWDM to solve fiber scarcity for CRAN is common. Higher rates are not expected before 2023.

8.2.5. 15 km RU-DU, semi-active DWDM over a single fiber Blueprint

This Blueprint is a combination of Blueprints 8.2.3 for the WDM part, and 7.2.1 for the WDM node to DU optics. In addition to those use cases, this Blueprint offers a WDM demarcation node.

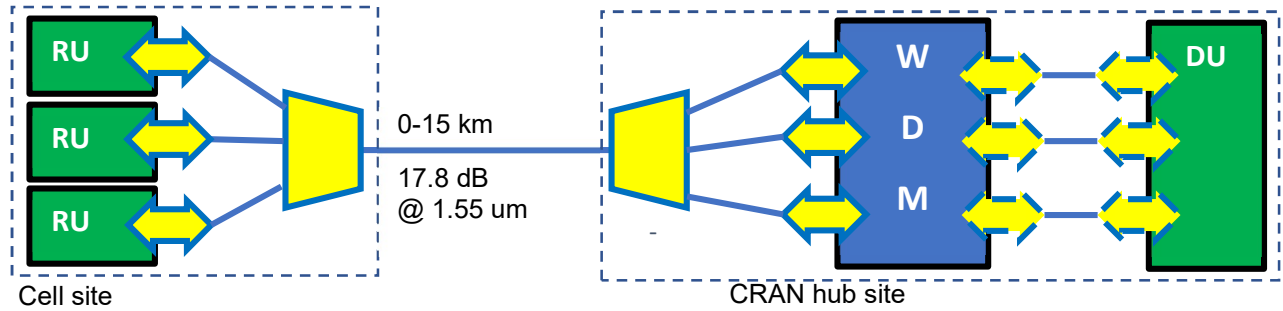

Figure 17: 15 km RU-DU semi-active wavelength multiplexed, P2P or P2MP Blueprint. The intraoffice pluggables at the hub site may be C-temp as indicated by dashed borders.

8.2.6. 2 km RU-DU packet multiplexing, dual or BiDi fiber Blueprint

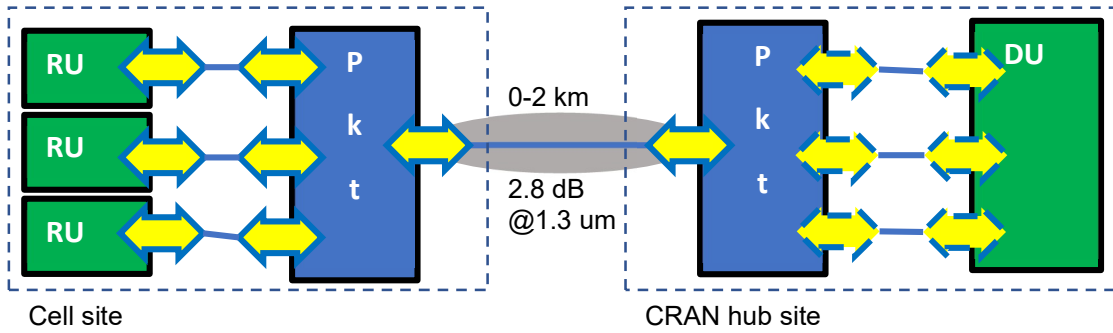

Figure 18 : 2 km RU-DU, packet multiplexing, P2P or P2MP Blueprint. The link specified has a gray background. There may be additional intermediate Pkt nodes between the depicted Pkt node and DU, for example on case of cloud RAN deployments at the hub site. The intraoffice pluggables at the hub site may be C-temp as indicated by dashed borders.

2 km RU-DU packet multiplexing Blueprint		
Typical use cases	DU to RU via packet-multiplexed interconnect, up to 2 km BiDi fiber between packet nodes. P2P (all RUs at the same location together with the optical multiplexer) or P2MP (the RUs in slightly different locations, with the packet multiplexer at one of those, or another location). Short reach 10G/25G optical links (<2km, see Blueprint 7.2.1) or direct attach copper cables (DAC) between Pkt node and the corresponding DU/RU.	
Distance	Typ Min 0 km; Typ. Max: 2 km	
Channel Insertion Loss	2.8 dB @1.3 um (For Typ. Max Distance)	
Mode, Nr ch., Wavelengths	Dual fiber: O-band 1310 nm. BiDi O-band 1270nm/1330 nm.	
Temp. Range/Class	I-temp	
Lifespan	15 years	
Data rates	25 Gb/s	100 Gb/s
Formfactor	SFP28	QSFP28
FEC, Mod. format	No, NRZ	Yes, PAM4 or NRZ for 4WDM
Power Class	PC4 (2.5 W)	PC4 (3.5 W)
Pluggables codes	25G-2km-O-G-1-2-SFP28 25G-2km-O-B2-2-1-SFP28	100G-2km-O-G-1-2-QSFP28 or 100G-2km-O-C/L-4-2-QSFP28 100G-2km-O-B2-2-1-QSFP28
Key Technologies	-	Low-cost integrated 4x25G WDM or single lambda 100G Tx and Rx. BiDi: 1270nm/1330nm BOSA with single lambda 100G.
Standards	Phy: Dual fiber: IEEE 802.3, Clause 114 (25GBASE-LR). Bidi: IEEE 802.3, Clause 159 (25GBASE-BR10) (**)	Phy: Dual fiber: IEEE 802.3, Clause 140 (100GBASE-FR1) or CWDM4 MSA (except relaxed IL). Bidi: No
Market status and outlook (*)	Mature	Dual fiber 100G 4WDM-10 mature for mobile transport; single lambda 100G emerging, adaptation to mobile transport requirements still an outstanding question.

Table 12: 2 km RU-DU packet multiplexing Blueprint. (*) Higher rates (400G) are not expected before 2023. (**) The current standard covers up to 10 km, but may not be cost optimized for 2 km.

8.2.7. 15 km RU-DU packet multiplexing, dual or BiDi fiber Blueprint

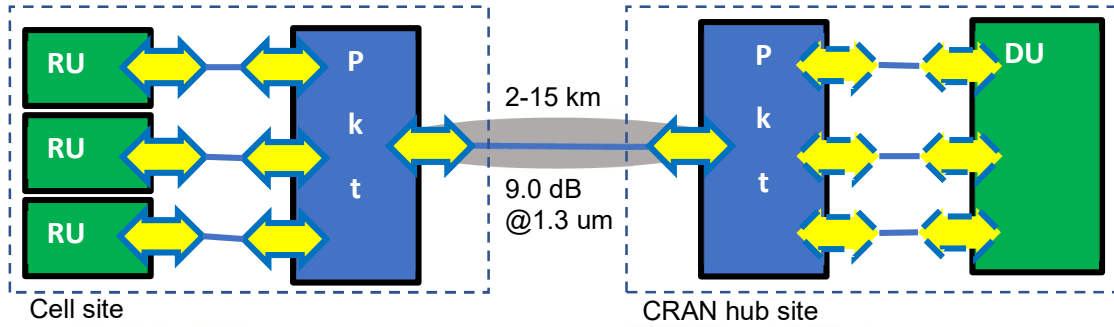

Figure 19: 15 km RU-DU packet multiplexed, P2P or P2MP Blueprint. The link specified has a gray background. There may be additional intermediate Pkt nodes between the depicted Pkt node and DU, for example on case of cloud RAN deployments at the hub site. The intraoffice pluggable at the hub site may be C-temp as indicated by dashed borders.

15 km RU DU packet multiplexed links Blueprint		
Typical use cases	DU to RU via packet-multiplexed interconnect, 2-15 km BiDi fiber between packet nodes. P2P (all RUs at the same location together with the optical multiplexer) or P2MP (the RUs in slightly different locations, with the packet multiplexer at one of those, or another location). Short reach 10G/25G optical links (<2 km, see Blueprint 7.2.1) or direct attach copper cables (DAC) between Pkt node and the corresponding DU/RU.	
Distance	Typ Min 0 km; Typ. Max: 15 km (*)	
Channel Insertion Loss	9.0 dB @ 1.3 um (For Typ. Max Distance)	
Mode, Nr ch., Wavelengths	Dual fiber: O-band 1310 nm. BiDi O-band 1270 nm/1330 nm.	
Temp. Range/Class	I-temp	
Lifespan	15 years	
Data rates	25 Gb/s	100 Gb/s
Formfactor	SFP28	QSFP28
FEC, Mod. format	Yes, NRZ	Yes, PAM4 or NRZ for 4WDM
Power Class	PC4 (2.5 W)	PC4 (3.5 W)
Pluggables codes	25G-15 km-O-G-1-2-SFP28 25G-15 km-O-B2-2-1-SFP28	100G-15 km-O-G-1-2-QSFP28 or 100G-15 km-O-L-4-2-QSFP28 100G-15 km-O-B2-2-1-QSFP28
Key Technologies	-	Low-cost integrated 4x25G WDM or single lambda 100G Tx and Rx. BiDi: 1270 nm/1330 nm BOSA with single lambda 100G.
Standards	Phy: Dual fiber: No (***) Bidi: IEEE 802.3, Clause 159 (25GBASE-BR20, except wavelength range)	Phy: Dual fiber: 100G Lambda MSA (100G-LR1-20) or 100G-4WDM-20 MSA. Bidi: No
Market status and outlook (**)	Mature	Dual fiber 100G 4WDM-20 mature for mobile transport; single lambda 100G emerging, adaptation to mobile transport requirements still an outstanding question.

Table 13: 15 km RU-DU packet multiplexing Blueprint. (*) For 100G, 10 km is more cost-effective at this point, while 15 km is the desirable reach for all CRAN LLS deployment cases. (**) Higher rates (400G) are not expected before 2023. (***) ER (40 km) could be used while significantly over specified.

9. Mobile Optical Solution Blueprints for Backhaul and HLS

9.1. Overview

The mobile backhaul transport network connects the RAN segment with the mobile core segment and has a tiered hierarchical packet aggregation architecture [GSTR-TN5G]. The mobile HLS transport network connects the DUs and the CUs within the RAN. In both cases, the requirements on the transport traffic in terms of latency, delay variance and throughput are less stringent compared with LLS.

The figures below show the overall architectures for backhaul and HLS for DRAN and VRAN, and CRAN. The term *multi-service* is used generically to indicate any type of WDM, packet, TDM, etc., transport network used for different types of services, such as mobile access, enterprise site connectivity, residential connectivity, etc.

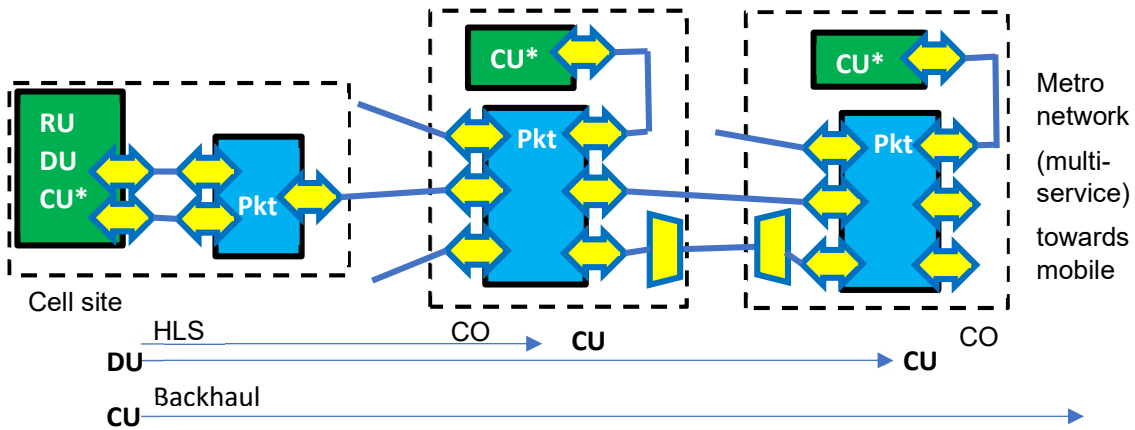

Figure 20: Backhaul and HLS for DRAN and virtual RAN. CU* indicates possible locations for the CU, at the cell site, or at the closest CO. The latter constitutes the VRAN case. The pluggables at the CO sites may be C-temp as indicated by dashed borders for the intraoffice ones.

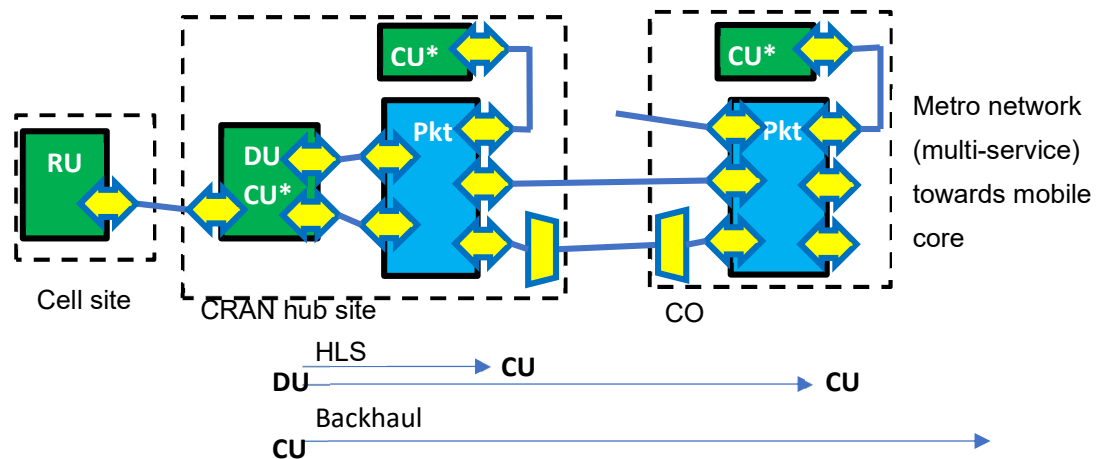

Figure 21: Backhaul and HLS for CRAN. CU* indicates possible locations for the CU, at the CRAN hub site, or at the CO. The latter constitutes the VRAN case. The pluggables at the CRAN hub and CO sites may be C-temp as indicated by dashed borders for the intraoffice ones.

Both DRAN backhaul and CRAN LLS can experience fiber abundance or fiber scarcity in the access part (i.e., between the cell site and the hub site).

When fiber is relatively abundant, it allows for point-to-point parallel fiber links to the individual cell sites, possibly with duplex or BiDi fiber solutions. In scenarios where fiber is more scarce, cost-effective solutions like WDM and TDM-PONs are attractive. TDM-PONs are based on bidirectional use of a common single feeder fiber which is then shared between multiple cell sites by a passive splitter and individual but shorter drop fibers. A single optic in the OLT is shared over multiple ONUs in the cell sites. More information about TDM-PONs and the different standards can be found in [TDM-PON].

In this backhaul access network segment, sometimes also called *Lo-RAN*, located between the cell site packet node and the first level of aggregation, 10 Gb/s 10 km links are typical with 25 Gb/s needed in some places in the near-medium term.

In the backhaul aggregation segment, sometimes also called *Hi-RAN*, which also applies to CRAN backhaul, 100 Gb/s links are typical with distances ranging from 10 km to 40 km, with a non-negligible minority of links demanding even longer reach and different scenarios of fiber resources availability. Traffic increase predictions suggest 400 Gb/s solutions could be needed in the near future. At this point, unamplified DWDM links at 25G per channel are challenging to make cost-effectively beyond 15 km. However, as the technology evolves, there's a need for up to 40 km links as stated above.

Except for the packet nodes at cell sites, other packet equipment is hosted in a temperature-controlled indoor environment and it is hence possible to use optical pluggables supporting the so-called *C-temp*, with operating case temperatures in the 0° C to 70° C range.

9.2. Backhaul and HLS Optical Blueprints

9.2.1. 2 km DRAN intraoffice backhaul, direct parallel fibers, dual fiber Blueprint

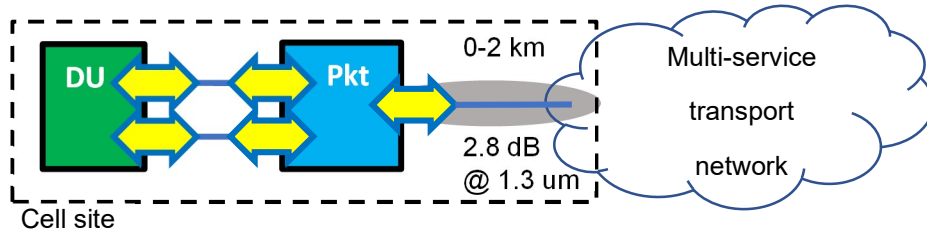

Figure 22: 2 km DRAN intraoffice backhaul direct dual fiber Blueprint. The link specified has a gray background. In cases where the cell site DU is collocated with the CU, backhaul is illustrated. If the CU is located at another location, HLS is illustrated.

2 km intraoffice backhaul Blueprint			
Typical use cases	DRAN cell site packet node to leased line service, e.g., AAV with local (i.e., box at cell site) demarcation node, providing the transport to the metro transport network.		
Distance	Typ Min 0 km; Typ. Max: 2 km		
Channel Insertion Loss	2.8dB @ 1.3 um (For Typ. Max Distance)		
Mode, Nr ch.,	Dual fiber: O-band 1310 nm		
Temp. Range/Class	I-temp		
Lifespan	15 years		
Data rates	10 Gb/s	25 Gb/s	100 Gb/s
Formfactor	SFP+	SFP28	QSFP28
FEC, Mod. format	No, NRZ	Yes, NRZ	Yes, PAM4 or NRZ for 4WDM
Power Class	PC2 (1.5 W)	PC2 (1.5 W)	PC4 (3.5 W)
Pluggables codes	10G-2km-O-G-1-2-SFP+	25G-2km-O-G-1-2-SFP28	100G-2km-O-G-1-2-QSFP28 or 100G-2km-O-C-4-2-QSFP28
Key technologies	-	Low-cost 25G DFB	Low-cost integrated 4x25G WDM or "single lambda" 100G Tx and Rx.
Standards	Phy: Dual fiber: IEEE 802.3, Clause 52 (10GBASE-L). (**)	Phy: Dual fiber: IEEE 802.3, Clause 114 (25GBASE-LR). (**)	Phy: Dual fiber: IEEE 802.3, Clause 140 (100GBASE-FR1) or CWDM4 MSA (except relaxed IL).
Market status and outlook (*)	Mature and relatively common case	Emerging, complement to 10G	Few cases but emerging.

Table 14: 2 km intraoffice backhaul Blueprint. (*) Higher rates (400G) are not expected before 2023. (**) The current standard covers up to 10 km, but may not be cost optimized for 2 km.

9.2.2. 10 km DRAN backhaul, direct parallel fibers, dual and BiDi fiber Blueprint

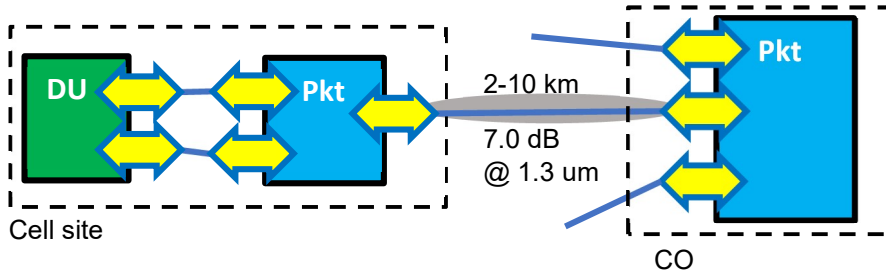

Figure 23: 10 km DRAN backhaul with direct parallel fiber, dual or BiDi Blueprint. The link specified has a gray background. In cases where the cell site DU is collocated with the CU, backhaul is illustrated. If the CU is located at another location, HLS is illustrated.

10 km DRAN backhaul direct parallel fiber Blueprint			
Typical use cases	DRAN cell site packet node to CO packet aggregation node.		
Distance	Typ Min 2 km; Typ. Max: 10 km		
Channel Insertion Loss	7.0 dB @1.3 um (For Typ. Max Dist.)		
Mode, Nr ch., Wavelengths	Dual fiber: O-band 1310 nm. BiDi O-band 1270nm/1330 nm.		
Temp. Range/Class	I-temp		
Lifespan	15 years		
Data rates	10 Gb/s	25 Gb/s	100 Gb/s
Formfactor	SFP+	SFP28	QSFP28
FEC, Mod. format	No, NRZ	Yes, NRZ	Yes, PAM4 or NRZ for 4WDM
Power Class	PC2 (1.5 W)	PC2 (1.5 W)	PC4 (3.5 W)
Pluggables codes	10G-10 km-O-G-1-2-SFP+ 10G-10 km-O-B2-2-1-SFP+	25G-10 km-O-G-1-2-SFP28 25G-10 km-O-B2-2-1-SFP28	100G-10 km-O-G-1-2-QSFP28 or 100G-10 km-O-C/L-4-2-QSFP28 100G-10 km-O-B2-2-1-QSFP28
Key technologies	-	Low-cost 25G DFB	Low-cost integrated 4x25G WDM or single lambda 100G Tx and Rx. BiDi: 1270nm/1330nm BOSA with single lambda 100G.
Standards	Phy: Dual fiber: IEEE 802.3, Clause 52 (10GBASE-L, except for 6.2 vs. 7.0 dB IL), Bidi: IEEE 802.3, Clause 158 (10GBASE-BR10, except 6.2 vs. 7.0 dB IL, or 10GBASE-BR20)	Phy: Dual fiber: IEEE 802.3, Clause 114 (25GBASE-LR, except 6.3 vs. 7.0 dB IL) Bidi: IEEE 802.3, Clause 159 (25GBASE-BR10, except 6.3 vs. 7.0 dB IL, or 25GBASE-BR20, except wavelength range)	Phy: Dual fiber: IEEE 802.3, Clause 140 (100GBASE-LR1, except 6.3 vs. 7.0 dB IL) or IEEE 802.3, Clause 88 (100GBASE-LR4, except IL and no FEC), BiDi: No
Market status and outlook (*)	Mature and relatively common case.	Emerging, complement to 10G.	Few cases but emerging.

Table 15: 10 km DRAN backhaul direct parallel fiber Blueprint. (*) The fiber abundance 10 km case is common for DRAN backhaul.

9.2.3. 40 km DRAN backhaul, direct parallel fibers, dual and BiDi fiber Blueprint

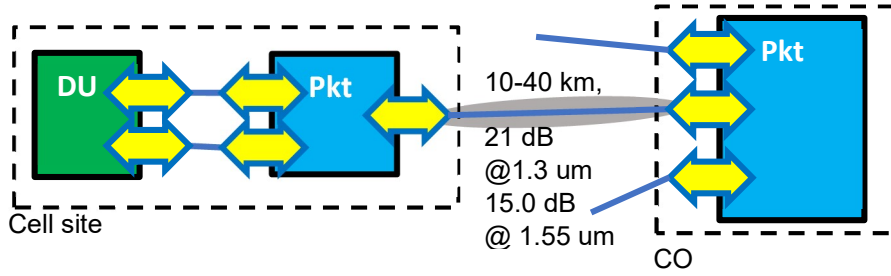

Figure 24: 40 km DRAN backhaul direct parallel fiber, dual or BiDi Blueprint. The link specified has a gray background. In cases where the cell site DU is collocated with the CU, backhaul is illustrated. If the CU is located at another location, HLS is illustrated.

40 km DRAN backhaul direct parallel fiber Blueprint			
Typical use cases	DRAN cell site packet node to CO packet aggregation node.		
Distance	Typ Min 10 km; Typ. Max: 40 km (*)		
Channel Insertion Loss	21.0 dB @ 1.3 um (O-band), 15.0 dB @ 1.55 um (For Typ. Max Distance)		
Mode, Nr ch., Wavelengths	Dual fiber: for 10G: C-band 1.55 um. For 25G and 100G O-band 1.3 um. BiDi O-band 1270nm/1330 nm.		
Temp. Range/Class	I-temp		
Lifespan	15 years		
Data rates	10 Gb/s	25 Gb/s	100 Gb/s
Formfactor	SFP+	SFP28	QSFP28
FEC, Mod. format	No, NRZ	Yes, NRZ	Yes, PAM4 or NRZ for 4WDM
Power Class	PC4 (2.5 W)	PC4 (2.5 W)	PC4 (3.5 W)
Pluggables codes	10G-40 km-C-G-1-2-SFP+ 10G-40 km-O-B2-2-1-SFP+	25G-40 km-O-G-1-2-SFP28 25G-40 km-O-B2-2-1-SFP28	100G-40 km-O-G-1-2-QSFP28, or 100G-40 km-O-L-4-2-QSFP28 100G-40 km-O-B2-2-1-QSFP28
Key technologies	-	Low-cost 25G EML	Low-cost integrated 4x25G WDM or single lambda 100G Tx and Rx. BiDi: 1270nm/1330nm BOSA with single lambda 100G.
Standards	Phy: Dual fiber: IEEE 802.3, Clause 52 (10GBASE-E, except 10.9 vs. 15 dB IL), Bid: IEEE 802.3, Clause 158 (10GBASE-BR40, except 18 vs. 21 dB IL)	Phy: Dual fiber: IEEE 802.3, Clause 114 (25GBASE-ER, except 15 vs. 21 dB IL). Bid: IEEE 802.3, Clause 159 (25GBASE-BR40, except 18 vs. 21 dB IL and wavelength range)	Phy: Dual fiber: 100G Lambda MSA (100G-ER1-40, except 18 vs. 21 dB IL) or IEEE 803.3 Clause 88 (100GBASE-ER4, except IL and no FEC) or 4WDM-40 MSA (except IL), BiDi: No
Market status and outlook (**)	Mature and relatively common case.	Emerging, complement to 10G.	Few cases but emerging.

Table 16: 40 km DRAN backhaul direct parallel fiber Blueprint. (*) 40 km is challenging for 25G and 100G. (**) The fiber abundance 40 km case is common, but less than 10 km, for DRAN backhaul.

9.2.4. 15 km DRAN backhaul, passive DWDM bus over a single fiber Blueprint

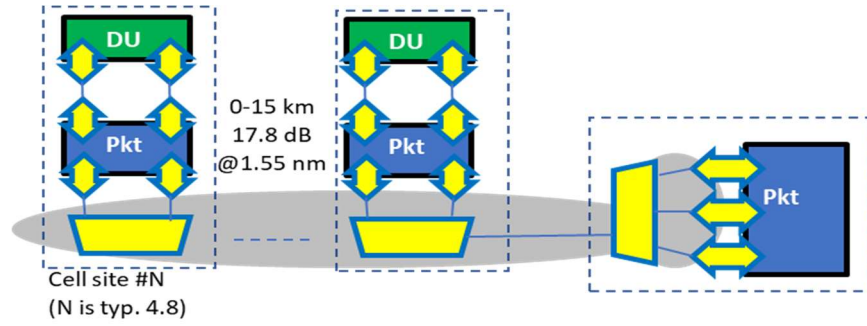

Figure 25: 15 km DRAN backhaul, DWDM passive wavelength multiplexed bus Blueprint. The link specified has a gray background. In cases where the cell site DU is collocated with the CU, backhaul is illustrated. If the CU is located at another location, HLS is illustrated.

15 km DRAN backhaul DWDM bus Blueprint		
Typical use cases	DRAN cell site packet node to CO packet aggregation. Up to 15 km DWDM bus or horseshoe topologies with headend CO(s) and multiple add/drop cell sites. Links up to 24 SFP+ pairs using the same single trunk fiber.	
	<ul style="list-style-type: none"> - Flexible use of the available loss budget up to 17.8 dB. (*) - Max number of added/dropped channel at each OADM: 6. - Number of OADMs : Up to 8. 	
Distance	Typ Min 0 km; Typ. Max: 15 km	
Channel Insertion Loss	Max 17.8 dB to use for the fiber (max 6.8 dB @ 1.55 um), 0.6 dB per OADM pass and 3.0 dB for add/drop (up to 8 OADMs (**)).	
Chromatic Dispersion	270 ps/nm	
Mode, Nr ch., Wavelengths	Dual fiber pluggables, single fiber trunk between MUX and OADM: 48 wavelengths @ 0.8 nm/100 GHz spacing.	
Temp. Range	I-temp	
Lifespan	15 years	
Data rates	10 Gb/s	25 Gb/s
Formfactor	SFP+	SFP28
FEC, Mod format	No, NRZ	Yes, NRZ
Power Class	PC4 (2.5 W)	PC4 (2.5 W)
Pluggables codes	10G-15 km-C-D-48-2-SFP+	25G-15 km-C-D-48-2-SFP28
Key technologies	Low-cost EML DWDM, without wavelength lockers. Athermal AWG and OADM TFF filters.	
Standards	Phy: ITU-T G.698.1, Table 8.3, NRZ 10G 100 GHz spacing short-haul (except for relaxed chromatic dispersion)	Phy: No
Market status and outlook (***)	Mature.	25G: emerging, expected to complement 10G over time.

Table 17: 15 km DRAN backhaul DWDM bus Blueprint. (*) Same comments for loss budget and flexible use as Blueprint 8.2.4. (**) Typical no. of OADMs are 4-6, with cases of 7-8 expected to be few. (***) Using DWDM to solve fiber scarcity for backhaul is common. Higher rates are not expected before 2023.

9.2.5. 2 km CRAN intraoffice backhaul, direct parallel fibers, dual fiber Blueprint

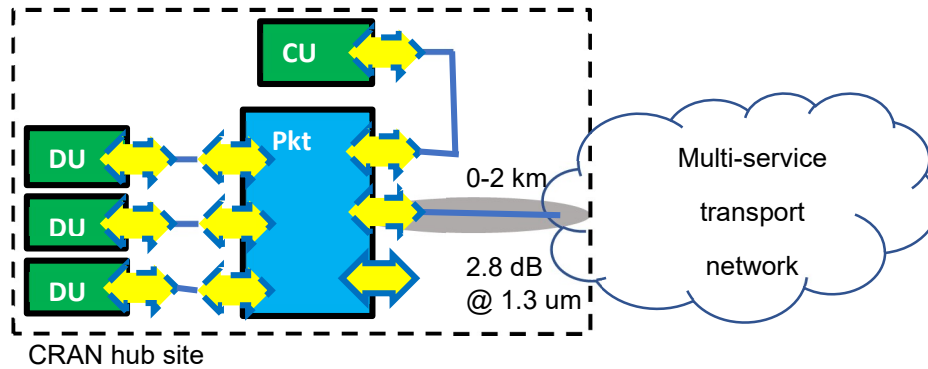

Figure 26: 2 km CRAN hub site intraoffice backhaul direct parallel fiber Blueprint. The link specified has a gray background. In cases where the CU is located at another location, HLS is illustrated. The pluggables at the CRAN hub site may be C-temp as indicated by dashed borders for the intraoffice ones.

2 km intraoffice CRAN hub site intraoffice backhaul Blueprint			
Typical use cases	CRAN hub site packet node to leased line service, e.g., AAV, with local (i.e., box at cell site) demarcation node, providing the transport to the metro transport network.		
Distance	Typ Min 0 km; Typ. Max: 2 km		
Channel Insertion Loss	2.8 dB @ 1.3 um (For Typ. Max Distance)		
Mode, Nr ch., Wavelengths	Dual fiber: O-band 1310 nm		
Temp. Range/Class	I-temp (preferred) or C-temp (see section 6.1)		
Lifespan	15 years		
Data rates	10 Gb/s	25 Gb/s	100 Gb/s
Formfactor	SFP+	SFP28	QSFP28
FEC, Mod. format	No, NRZ	Yes, NRZ	Yes, PAM4 or NRZ for 4WDM
Power Class	PC2 (1.5 W)	PC2 (1.5 W)	PC4 (3.5 W)
Pluggables codes	10G-2 km-O-G-1-2-SFP+	25G-2 km-O-G-1-2-SFP28	100G-2 km-O-G-1-2-QSFP28, or 100G-2 km-O-C-4-2-QSFP28
Key technologies	-	Low-cost 25G DFB	Low-cost integrated 4x25G WDM or single lambda 100G Tx and Rx.
Standards	Phy: Dual fiber: IEEE 802.3, Clause 52 (10GBASE-L). (**)	Phy: Dual fiber: IEEE 802.3, Clause 114 (25GBASE-LR). (**)	Phy: Dual fiber: IEEE 802.3, Clause 140 (100GBASE-FR1) or CWDM4 MSA (except relaxed IL).
Market status and outlook (*)	Mature and relatively common case.	Emerging, complement to 10G.	Few cases but emerging.

Table 18: 2 km CRAN hub site intraoffice backhaul Blueprint. (*) Higher rates (400G) are not expected before 2023. (**) The current standard covers up to 10 km, but may not be cost optimized for 2 km.

9.2.6. 10 km CRAN backhaul, direct parallel fibers, dual and BiDi fiber Blueprint

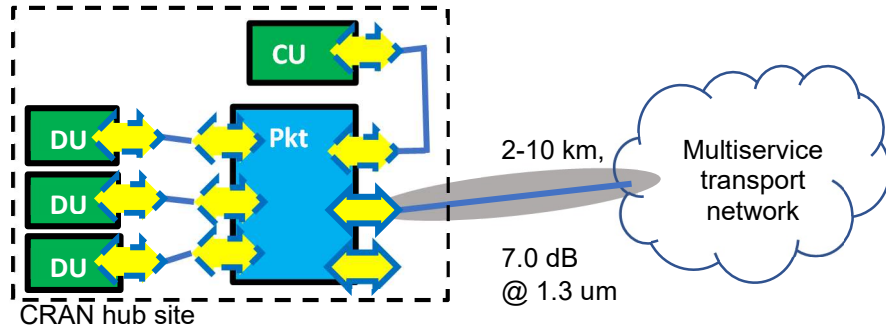

Figure 27: 10 km CRAN backhaul Blueprint (direct P2P, no WDM). The link specified has a gray background. In cases where the CU is located at another location, HLS is illustrated. The pluggables at the CRAN hub site may be C-temp as indicated by dashed borders for the intraoffice ones.

10 km CRAN hub site backhaul direct parallel fiber Blueprint			
Typical use cases	CRAN hub site Pkt node to Multiservice transport network at another site.		
Distance	Typ Min 2 km; Typ. Max: 10 km		
Channel Insertion Loss	7.0 dB @ 1.3 um (For Typ. Max Distance)		
Mode, Nr ch., Wavelengths	Dual fiber: O-band 1310 nm. BiDi O-band 1270nm/1330 nm.		
Temp. Range/Class	I-temp (preferred) or C-temp (see Section 6.1).		
Lifespan	15 years		
Data rates	10 Gb/s	25 Gb/s	100 Gb/s
Formfactor	SFP+	SFP28	QSFP28
FEC, Mod. format	No, NRZ	Yes, NRZ	Yes, PAM4 or NRZ for 4WDM
Power Class	PC2 (1.5 W)	PC2 (1.5 W)	PC4 (3.5 W)
Pluggables codes	10G-10 km-O-G-1-2-SFP+ 10G-10 km-O-B2-2-1-SFP+	25G-10 km-O-G-1-2-SFP28 25G-10 km-O-B2-2-1-SFP28	100G-10 km-O-G-1-2-QSFP28, or 100G-10 km-O-C/L-4-2-QSFP28 100G-10 km-O-B2-2-1-QSFP28
Key technologies	-	Low-cost 25G DFB	Low-cost integrated 4x25G WDM or single lambda 100G Tx and Rx. BiDi: 1270 nm/1330 nm BOSA with single lambda 100G.
Standards	Phy: Dual fiber: IEEE 802.3, Clause 52 (10GBASE-L, except for 6.2 vs. 7.0 dB IL), Bidi: IEEE 802.3, Clause 158 (10GBASE-BR10, except 6.2 vs. 7.0 dB IL, or 10GBASE-BR20)	Phy: Dual fiber: IEEE 802.3, Clause 114 (25GBASE-LR, except 6.3 vs. 7.0 dB IL) Bidi: IEEE 802.3, Clause 159 (25GBASE-BR10, except 6.3 vs. 7.0 dB IL, or 25GBASE-BR20, except wavelength range)	Phy: Dual fiber: IEEE 802.3, Clause 140 (100GBASE-LR1, except 6.3 vs. 7.0 dB IL) or IEEE 802.3, Clause 88 (100GBASE-LR4, except IL and no FEC), BiDi: No
Market status and outlook (*)	Mature and relatively common case	Emerging, complement to 10G	Few cases but emerging.

Table 19: 10 km CRAN backhaul direct parallel fiber Blueprint. (*)The fiber abundance 10 km case is common for CRAN backhaul.

9.2.7. 40 km CRAN backhaul, direct parallel fibers, dual and BiDi fiber Blueprint

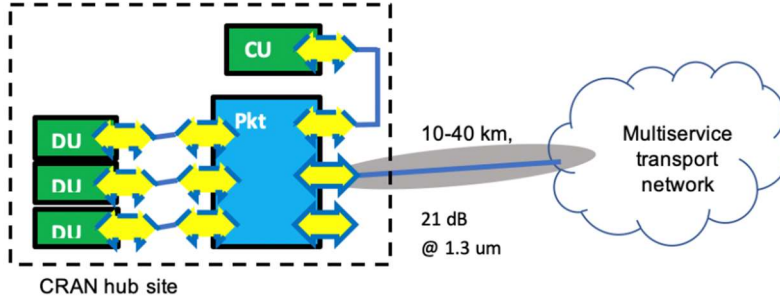

Figure 28: 40 km CRAN hub site backhaul direct parallel fiber Blueprint. The link specified has a gray background. In cases where the CU is located at another location, HLS is illustrated. The pluggables at the CRAN hub site may be C-temp as indicated by dashed borders for the intraoffice ones.

40 km CRAN hub site backhaul direct parallel fiber Blueprint			
Typical use cases	CRAN hub site Pkt node to Multiservice transport network at another site.		
Distance	Typ Min 10 km; Typ. Max: 40 km (*)		
Channel Insertion Loss	21.0 dB @ 1.3 um (O-band), 15.0 dB @1.55 um (For Typ. Max Distance)		
Mode, Nr ch., Wavelengths	Dual fiber: For 10G: C-band 1.55 um. For 25G and 100G O-band 1.3 um. BiDi O-band 1270nm/1330 nm.		
Temp. Range/Class	I-temp (preferred) or C-temp (see Section 6.1).		
Lifespan	15 years		
Data rates	10 Gb/s	25 Gb/s	100 Gb/s
Formfactor	SFP+	SFP28	QSFP28
FEC, Mod. format	No, NRZ	Yes, NRZ	Yes, PAM4 or NRZ for 4WDM
Power Class	PC4 (2.5 W)	PC4 (2.5 W)	PC4 (3.5 W)
Pluggables codes	10G-40 km-C-G-1-2-SFP+ 10G-40 km-O-B2-2-1-SFP+	25G-40 km-O-G-1-2-SFP28 25G-40 km-O-B2-2-1-SFP28	100G-40 km-O-G-1-2-QSFP28, 100G-40 km-O-L-4-2-QSFP28 100G-40 km-O-B2-2-1-QSFP28
Key technologies	-	Low-cost 25G EML.	Low-cost integrated 4x25G WDM or single lambda 100G Tx and Rx. BiDi: 1270 nm/1330 nm BOSA with single lambda 100G.
Standards	Phy: Dual fiber: IEEE 802.3, Clause 52 (10GBASE-E, except 10.9 vs. 15 dB IL), Bidi: IEEE 802.3, Clause 158 (10GBASE-BR40, except 18 vs. 21 dB IL)	Phy: Dual fiber: IEEE 802.3, Clause 114 (25GBASE-ER, except 15 vs. 21 dB IL). Bidi: IEEE 802.3, Clause 159 (25GBASE-BR40, except 18 vs. 21 dB IL and wavelength range)	Phy: Dual fiber: 100G Lambda MSA (100G-ER1-40, except 18 vs. 21 dB IL) or IEEE 803.3 Clause 88 (100GBASE-ER4, except IL and no FEC) or 4WDM-40 MSA (except IL), BiDi: No
Market status and outlook (**)	Mature and relatively common case.	Emerging, complement to 10G.	Few cases but emerging.

Table 20: 40 km CRAN backhaul direct parallel fiber Blueprint. (*) 40 km is challenging for 25G and 100G. (**) The fiber abundance 40 km case is less common than 10 km for CRAN backhaul

9.2.8. 15 km CRAN backhaul, passive DWDM over a single trunk fiber Blueprint

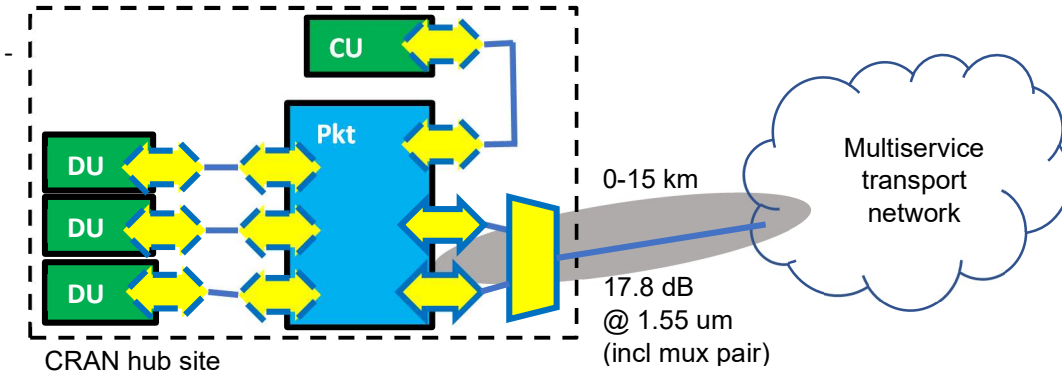

Figure 29: 15 km CRAN backhaul, DWDM passive wavelength multiplexed Blueprint. In cases where the CU is located at another location, HLS is illustrated.

10 km CRAN hub site backhaul DWDM Blueprint		
Typical use cases	CRAN hub site Pkt node to Multiservice transport network at another site. Up to 15 km DWDM P2P links with up to 24 SFP+ pairs using the same single trunk fiber.	
Distance	Typ Min 0 km; Typ. Max: 15 km	
Channel Insertion Loss	6.8 dB @1.55 um for the fiber, 5.5 dB per WDM mux, total 17.8 dB.(For Typ. Max Distance)	
Chromatic Dispersion	270 ps/nm	
Mode, Nr ch., Wavelengths	Dual fiber pluggables, single fiber trunk: 48 wavelengths @ 0.8nm/100GHz spacing	
Temp. Range/Class	I-temp (preferred) or C-temp (see Section 6.1)	
Lifespan	15 years	
Data rates	10 Gb/s	25 Gb/s
Formfactor	SFP+	SFP28
FEC, Mod. format	No, NRZ	Yes, NRZ
Power Class	PC4 (2.5 W)	PC4 (2.5 W)
Pluggables codes	10G-15km-C-D-48-2-SFP+	25G-15km-C-D-48-2-SFP28
Key technologies	Low-cost EML DWDM, without wavelength lockers. Athermal AWG and TFF filters.	
Standards	Phy: ITU-T G.698.1, Table 8.3, NRZ 10G 100 GHz spacing short-haul (except for relaxed chromatic dispersion)	Phy: No
Market status and outlook (*)	Mature.	25G: emerging, expected to complement 10G over time.

Table 21: 10 km CRAN hub site backhaul DWDM Blueprint. (*) Intraoffice or direct fiber cases are expected to be more common. Higher rates are not expected before 2023.

9.2.9. 20 km DRAN Backhaul and HLS with TDM-PON, Separate ONU box Blueprint

There are several PON technologies that are relevant for backhaul and HLS transport. A PON system consists of OLT and multiple subtended ONUs. The ONU functionality at the cell site can be provided as a separate ONU box as shown in this Blueprint.

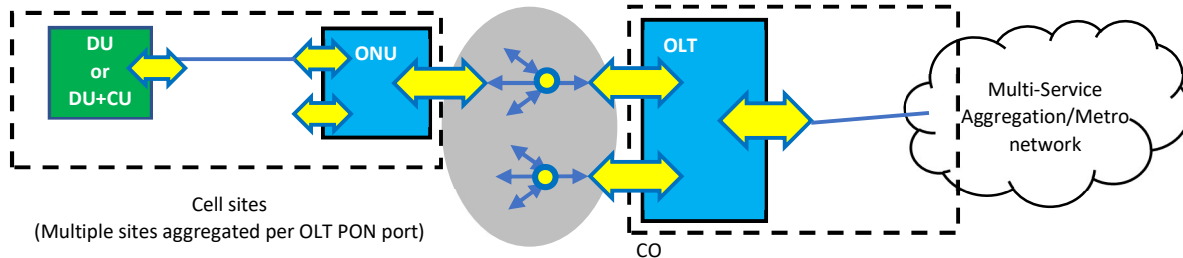

Figure 30 : Up to 20 km Backhaul and HLS with TDM-PON using separate ONU box. HLS is depicted in cases where the CU is centralized. Backhaul is depicted in cases where the CU is located at the cell site.

20 km DRAN Backhaul and HLS with TDM-PON, Separate ONU box Blueprint			
Typical use cases	Transport from small or medium cell site with DU and optionally CU functionality to the multiservice transport network at another site. The separate ONU box can act as a demarcation point, and as an aggregating point at the cell site when having multiple interfaces. For cases where there is available space for an external transport box at the cell site.		
Distance	Typ. Max: 20 km		
Transmission mode	Single fiber (BiDi)		
Temp. Range/Class	I-temp		
Lifespan	15 years		
Data rates Down / Up (shared) & technology	2.5 Gb/s / 1.25 Gb/s GPON	10 Gb/s / 10 Gb/s XGS-PON or 10G EPON	25 Gb/s / 10Gb/s or 25 Gb/s 25GS-PON or 25G EPON
Channel Insertion Loss	B+ (28 dB), C+ (32 dB), C++ (34 dB). Highest class is Class D (35 dB).	N1 (29 dB) and N2 (31 dB). Higher classes are E1 (33 dB) and E2 (35 dB).	Starting at N1 (29 dB). Higher classes (N2, E1 ,E2) for longer term.
Wavelength bands	1300-1320 nm Up 1480-1500 nm Down	1260-1280 nm Up 1575-1580 nm Down	Multiple waveband options in the O-band (Up and Down) depending on co-existence requirements.
Formfactor	SFP, SFP-DD for dual OLT	SFP+	SFP28
FEC	Yes	Yes	Yes
Power Class	Dual OLT module: PC4 (2.5 W) Single OLT module: PC2 (1.5 W) ONU module: PC2 (1.5 W)	OLT module: PC4 (2.5 W) ONU module: PC3 (2 W)	OLT module: PC4 (2.5 W) ONU module: PC4 (2.5 W), evolution to PC3 (2 W) is desired.
Pluggables codes	GPON-20 km-OS-B3-1-SFP-OLT GPON-20 km-OS-B3-1-SFP-ONU	XGS-PON-20 km-OL-B3-1-SFP+-OLT XGS-PON-20 km-OL-B3-1-SFP+-ONU	25GS-PON-20 km-O-B3-1-SFP28-OLT 25GS-PON-20 km-O-B3-1-SFP28-ONU
Key technologies	BOSA with DML and PIN or APD.	BOSA with EML and APD.	BOSA with EML and APD.
Standards (Phy & MAC)	[G.984.x]	[G.9807.x], [10GEPON]	[25GS-PON], [802.3ca]
Market status and outlook	Mature, mass deployment, common case for FTTx and backhaul.	Mature, dominating in more recent deployments, new cases for x-haul.	Emerging technology, future deployment.

Table 22: 20 km DRAN Backhaul and HLS with TDM-PON, Separate ONU box Blueprint. (Note: There are also SFP family-based OLT modules combining both XGS-PON and GPON in a single fiber.)

© 2022 Ericsson, Nokia, II-VI, Lumentum and Sumitomo Electric.

This document may be freely reproduced and distributed whole and intact including this Copyright Notice."

9.2.10. 20 km DRAN Backhaul and HLS with TDM-PON, Pluggable ONU

Instead of an external box, the cell site ONU functionality can be integrated into the pluggable optic (*Pluggable ONU*, also known as *ONU on a stick* or *Integrated ONU (iONU)*).

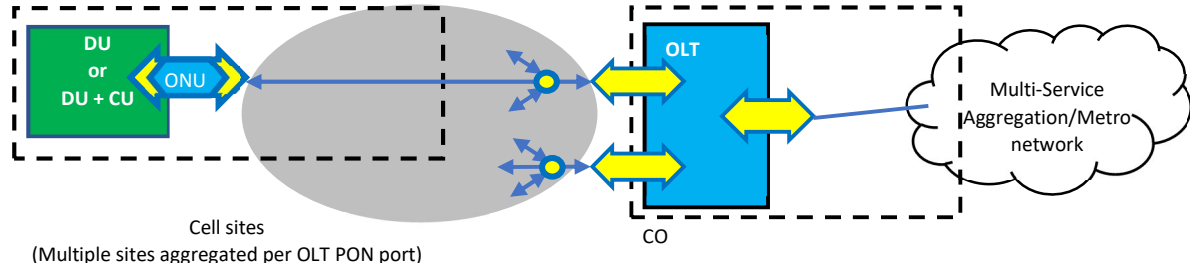

Figure 31: Up to 20 km backhaul and HLS with TDM-PON using pluggable ONU. HLS is depicted in cases where the CU is centralized. Backhaul is depicted in cases where the CU is located at cell site.

20 km DRAN Backhaul and HLS with TDM-PON, Pluggable ONU Blueprint			
Typical use cases	Transport from small or medium cell site with DU and optionally CU functionality to multiservice transport network at another site. Preferred solution if there is no space for external transport box at cell site.		
Distance	Typ. Max: 20 km		
Transmission mode	Single fiber (BiDi)		
Temp. Range/Class	I-temp		
Lifespan	15 years		
Data rates Down / Up (shared) & technology	2.5 Gb/s / 1.25 Gb/s GPON	10/10 Gb/s XGS-PON or 10G EPON	25 Gb/s / 10 Gb/s or 25 Gb/s 25GS-PON or 25G EPON
Channel Insertion Loss	B+ (28 dB), C+ (32 dB), C++ (34 dB). Highest Class D (35 dB)	N1 (29 dB) and N2 (31 dB). High classes E1 (33 dB) and E2 (35 dB)	Starting at N1 (29 dB). Higher classes (N2, E1, E2) for longer term.
Wavelength bands	1300-1320 nm Up 1480-1500 nm Down	1260-1280 nm Up 1575-1580 nm Down	Multiple waveband options in the O-band depending on co-existence requirements.
Formfactor	SFP, SFP-DD for dual OLT	SFP+	SFP28
FEC	Yes	Yes	Yes
Power Class	Dual OLT module: PC4 (2.5 W) Single OLT module: PC2 (1.5 W) integrated ONU module: PC3 (2 W)	OLT module: PC4 (2.5 W) Integrated ONU module: PC4 (2.5 W), evolution to PC3 (2 W) is desired	OLT module: PC4 (2.5 W) Integrated ONU module: TBD.
Pluggables codes	GPON-20 km-OS-B3-1-SFP-OLT GPON-20 km-OS-B3-1-SFP-iONU	XGS-PON-20 km-OL-B3-1-SFP+-OLT XGS-PON-20 km-OL-B3-1-SFP+-iONU	25GS-PON-20 km-O-B3-1-SFP28-OLT 25GS-PON-20 km-O-B3-1-SFP28-iONU
Key technologies	BOSA w. DML and PIN or APD. Pluggable also contains SoC for ONU PON MAC.	BOSA with EML and APD. Pluggable also contains SoC for ONU PON MAC.	BOSA with EML and APD. Pluggable also contains SoC for ONU PON MAC.
Standards (Phy & MAC)	[G.984.x]	[G.9807.x], [10GEPON]	[25GS-PON], [802.3ca]
Market status and outlook	GPON is mature, established mass deployment, common case for FTTx and backhaul.	XGS-PON is mature, used in recent deployments, new cases for x-haul. Pluggable ONU is emerging.	Emerging technology, future deployment.

Table 23 : 20 km DRAN Backhaul and HLS with TDM-PON, Pluggable ONU Blueprint. (Note: There are also SFP family-based OLT modules combining both XGS-PON and GPON in a single fiber.)

10. Summary of Optical Pluggables needed per Blueprint

The tables below summarize the pluggable variants used by the different Blueprints described in the paper. It should be noted that the tables in this section include all the pluggables used in the Blueprint illustrations, not only the ones highlighted and covered by the individual Blueprint tables, for example dual fiber 10G and 25G pluggables used to connect equipment within the same site.

The following codes are used for the 2nd row in the tables below:

- x: a pluggable that is the same at both ends
- y: a pluggable that is only at the network side (closer to mobile core network)
- z: a pluggable that is only at the access side (closer to the RU)

If the module type is the same at both ends, it gets an x in the table. If there are two module types, one for each end, there is both a y and a z in the table entry.

Pluggables vs Blueprints	10G-2 km-O-G-1-2-SFP+	10G-10 km-O-G-1-2-SED+	10G-15 km-O-G-1-2-SFP+	10G-40 km-C-G-1-2-SFP+	25G-2 km-O-G-1-2-SFP28	25G-10 km-O-G-1-2-SFP28	25G-15 km-O-G-1-2-SFP28	25G-40 km-O-G-1-2-SFP28	50G-2 km-O-G-1-2-SFP28	50G-10 km-O-G-1-2-SFP28	50G-15 km-O-G-1-2-SFP28	100G-2 km-O-G-1-2-QSFP28*	100G-10 km-O-G-1-2-QSFP28*	100G-15 km-O-G-1-2-QSFP28*	100G-40 km-O-G-1-2-QSFP28*
	x	x	x	x	x	x	x	x	x	x	x	x	x	x	x
7.2.1	o				o				o						
7.2.2		o				o				o					
8.2.1			o				o				o				
8.2.5	o					o									
8.2.6	o				o							o			
8.2.7	o				o		o							o	
9.2.1	o				o							o			
9.2.2	o	o			o	o							o		
9.2.3	o			o	o			o							o
9.2.4	o				o										
9.2.5	o				o							o			
9.2.6	o	o			o	o							o		
9.2.7	o			o	o			o							o
9.2.8	o				o										

Table 24: Summary of dual fiber client (only one pluggable pair using each fiber) pluggables needed for each Blueprint. (* The 100G dual fiber pluggables may also be 4x25G, e.g., 100G-40km-O-L-4-2-QSFP28)

Pluggables vs Blueprints	10G-2 km-O-B2-2-1-SFP+	10G-10 km-O-B2-2-1-SFP+	10G-15 km-O-B2-2-1-SFP+	10G-40 km-O-B2-2-1-SFP+	25G-2 km-O-B2-2-1-SFP28	25G-10 km-O-B2-2-1-SFP28	25G-15 km-O-B2-2-1-SFP28	25G-40 km-O-B2-2-1-SFP28	50G-2 km-O-B2-2-1-SFP28	50G-10 km-O-B2-2-1-SFP28	50G-15 km-O-B2-2-1-SFP28	100G-2 km-O-B2-2-1-QSFP28	100G-10 km-O-B2-2-1-QSFP28	100G-15 km-O-B2-2-1-QSFP28	100G-40 km-O-B2-2-1-QSFP28
	yz	yz	yz	yz	yz	yz	yz	yz	yz	yz	yz	yz	yz	yz	yz
7.2.1	o				o				o						
7.2.2		o				o				o					
8.2.1			o				o				o				
8.2.5															
8.2.6					o							o			
8.2.7							o							o	
9.2.1															
9.2.2		o				o							o		
9.2.3				o				o							o
9.2.4															
9.2.5															
9.2.6		o				o							o		
9.2.7				o				o							o
9.2.8															

Table 25: Summary of bidi client (only one pluggable pair using each fiber) pluggables needed for each Blueprint. (* The 100G dual fiber pluggables may also be 4x25G, e.g., 100G-40km-O-L-4-2-QSFP28)

Pluggables vs. Blueprints	10G-10 km*-C-6-2-SFP+	10G-15 km-C-D-48-2-SFP+	25G-15 km-C-D-48-2-SFP28
	x	x	x
8.2.2	o		
8.2.3		o	o
8.2.4		o	o
8.2.5		o	o
9.2.4		o	o
9.2.8		o	o

Table 26: Summary of line (multiple pluggable pairs sharing each fiber using WDM) pluggables needed for each Blueprint.

Pluggables vs. Blueprints	GPON-20 km-OS-B3-1-SFP-OLT	GPON-20 km-OS-B3-1-SFP-ONU	GPON-20 km-OS-B3-1-SFP-iONU	XGSPON-20 km-OL-B3-1-SFP+-OLT	XGSPON-20 km-OL-B3-1-SFP+-ONU	XGSPON-20 km-OL-B3-1-SFP+-iONU	25GSPON-20 km-O-B3-1-SFP28-OLT	25GSPON-20 km-O-B3-1-SFP28-ONU	25GSPON-20 km-O-B3-1-SFP28-iONU
9.2.9	o	o		o	o		o	o	
9.2.10	o		o	o		o	o		o

Table 27: Summary of TDM-PON pluggables needed for each Blueprint.

11. Summary of important technologies, capabilities, and components not yet available

This section discusses technologies and features that are not yet available in current products but that are relevant to the evolution of the Blueprints described in the previous sections. The focus is on pluggable devices: other technological trends from which radio equipment could benefit, like co-packaged optics (CPO), are not covered by the current version of this paper.

11.1. Optical transceivers operating at high temperature

Optical transceivers operating at high temperatures are relevant to any equipment that may operate in a harsh environment, like the RUs in the Blueprints described in Sections 7 and 8. Telecom transceivers share most of the characteristics developed for datacom applications, but with some important differences. The capability to operate at temperatures higher than 100 °C is probably the most important one, due to the higher density of integrated circuits in new generation radio equipment. Due to the operation in an uncontrolled environment, and limitations in weight and size, solutions commonly used in data centers, such as active cooling, are more difficult to apply in radio systems. High-temperature pluggable transceivers would allow the radio equipment to become smaller and lighter, with positive effects on the speed and cost of network rollouts.

The first industry to use integrated photonics was that of datacom transceivers, where the high volumes enable important investments in new technologies. Unfortunately, while silicon photonics modulators and photodetectors are tolerant to high temperatures, current commercial lasers are not. Quantum dot lasers are a promising but not fully mature technology. External laser sources, placed far from the thermal hot spots, are an alternative solution, proposed today primarily for co-packaged optics.

11.2. Cost effective high-capacity transceivers

Aggregate capacities in the order of 10 Tb/s already common in WDM metro and long-haul networks, based on 100 Gb/s coherent pluggable modules and their evolution to 400 Gb/s. This is largely sufficient to fulfill even the most challenging requirements of a 5G transport network but a dramatic cost reduction is necessary before optical coherent modules can become suitable for this network segment (for example, see the DWDM Blueprints 8.2.3, 8.2.4, 9.2.8 and 9.2.4 described in the previous sections). We are today far from meeting this target, though integrated photonic technologies can help also in this case, for example integrating multiple optical front ends in a single monolithic InP photonic integrated circuits (PIC). Moving the DSP implementation to a 5 nm or lower scale further helps. However, no significant cost reduction is around the corner for key components like DAC/ADC, local oscillator lasers and modulator drivers. Simplified coherent solutions based on a heterodyne receiver and analogue processing have been proposed but they require high opto-electronic bandwidth and can hardly scale beyond 25 Gb/s.

A first step in the above direction could be a power and cost efficient 80 km 100G ZR in QSFP28 (DCO) form factor, to reduce the power and cost of 100G coherent pluggables and extending the reach of DWDM based CRAN blueprint 8.2.3 and 8.2.4.

Intensity-Modulated Direct-Detection (IM-DD) systems are currently simpler and more cost effective than coherent systems but suffer from poor distance and power budget performance at high bit rates. Extending the operation of NRZ optical interfaces beyond 25 Gb/s needs high-accuracy, tunable chromatic dispersion compensators that may be integrated in a TOSA/ROSA,

e.g., based on silicon nitride micro-rings. Increasing the number of modulation symbols, as in PAM4, is an alternative but it impairs receiver sensitivity, implementation complexity and cost. Where the right tradeoff between cost and performance lies, is still an open question. The success of 25 Gb/s in the access part of backhaul is expected to generate the need for single fiber solutions with 40 km reach, for example to extend the reach of the Blueprint 9.2.8, or with a link attenuation equal or higher than 21 dB, as in Blueprint 9.2.7.

11.3. Pluggable optical amplifiers and dispersion compensators

Though tolerated at CO and hub sites, optical amplifiers are not usually allowed at RU and cell sites due to their large footprint, power consumption and cost. Compact optical amplifiers implemented in Pluggable Optical Line System (POLS) would be highly beneficial, in these aspects, for DWDM Blueprints where wavelength filters introduce a high insertion loss (e.g., Blueprints 8.2.3, 8.2.4, 9.2.8 and 9.2.4) and could allow the upgrade at 25 Gb/s or higher bitrate of all current 10 Gb/s installation, which is impossible today due to link attenuation constraints.

Similar considerations hold for Dispersion Compensating Modules (DCM) that are today quite bulky. Pluggable implementations, possibly tunable to fit all practical network design cases and avoid inventory issues, would allow to extend the reach of 25G transceivers beyond 15 km and to continue to use cost effective IM-DD interfaces at bit rates higher than 25 Gb/s.

11.4. Cost-effective tunable filters and wavelength switches

One drawback of current DWDM systems is the need to keep the inventory of all variants of transceivers and OADMs working at different wavelengths. This is impractical in mobile transport applications where installation times and cost must be minimal. Reconfigurable OADMs (ROADM) would relieve operators from installing and storing many variants of fixed OADMs, by replacing them with a single reconfigurable device. However, the ROADMs used in optical metro networks are based on high-performance but expensive Wavelength Selective Switches (WSS). Silicon micro-ring resonators could be a promising technology to realize pluggable and low-cost ROADMs. They apply, for example, to Blueprints 8.2.4 and 9.2.4.

Tunable optical filters enable new mobile transport architectures for the same Blueprints, replacing the OADM with a cost-effective power splitter, according to a broadcast-and-select architecture. Current tunable filters based on MEMS, liquid crystals or thin film filters are either too big or only support a limited number of DWDM channels, as in NG-PON2. New silicon photonics designs would offer decreased size and cost.

12. Solutions under evaluation and future work

12.1. LLS using TDM-PON with separate ONU box

The industry has been exploring the possibility of using TDM-PON to provide connectivity between the RU and DU in a CRAN architecture with a Low Layer Split interface. Some of the challenges to accomplish this are bandwidth and latency.

- **Bandwidth.** LLS has higher bandwidth requirements than HLS. The RU interfaces are typically 10 Gb/s or 25 Gb/s rates. LLS variants that generate variable rate traffic can allow aggregation of several RUs on a 25G TDM-PON (and higher), provided the line rate is not fully used by each RU.
- **Latency.** The latency requirement for LLS is much tighter than HLS, in the order of 25-500 μ s one-way [eCPR]req]. Several efforts have been made to reduce the latency of TDM-PON in order to allow it to be used for certain distances. The methods include reduced burst sizes in the upstream and a real-time control interface (called Cooperative Transport Interface) between the DU scheduler and the OLT scheduler (called Cooperative DBA). These measures are specified in the following standards documents:
 - O-RAN CTI Specification [ORAN-CTI].
 - ITU-T G series supplement on Cooperative DBA [ITU G.Sup.71].

It should be noted that the Cooperative DBA and CTI concepts are still experimental and real-world conditions will be needed for the assessment of their potential.

An illustration for TDM-PON for LLS using an external ONU is shown in Figure 32.

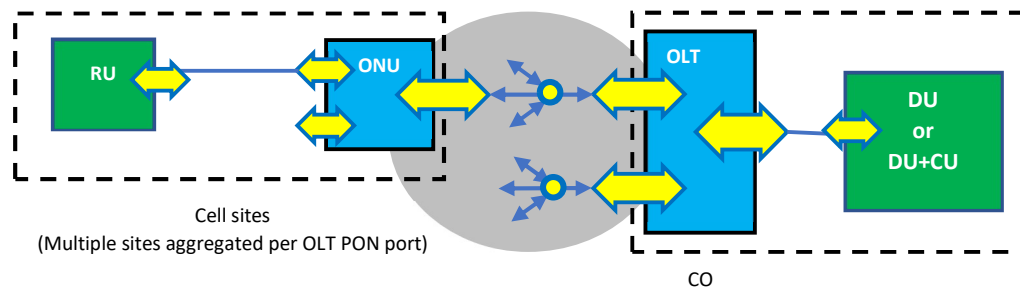

Figure 32: LLS using TDM-PON with separate ONU box.

12.2. LLS using TDM-PON with pluggable ONU

An illustration for TDM-PON for LLS using a pluggable ONU is shown in Figure 33. The ONU functionalities must be built into the optical module itself.

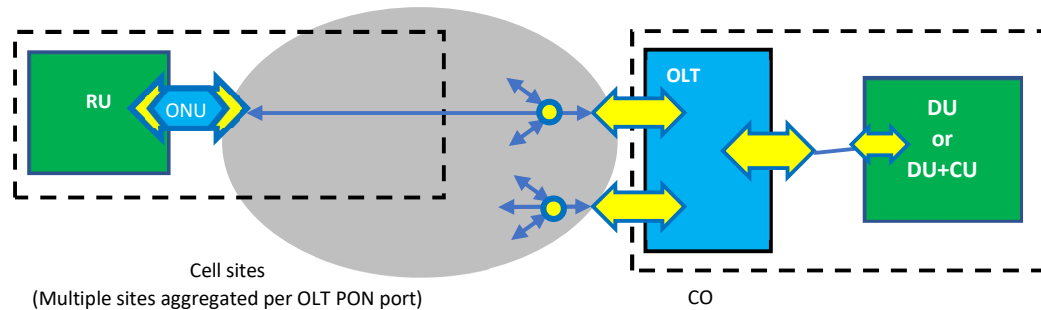

Figure 33: LLS using TDM-PON with a pluggable ONU module.

12.3. Higher speed TDM-PON technologies

The currently defined and available TDM-PON technology above 10G per wavelength is 25GS-PON [25GSPON]. ITU-T has specified Higher Speed PON (HSP) [G.9804.x] for asymmetrical 50/25 Gb/s. The specification for the physical layer of a 50G/50G symmetrical variant of HSP is still work in progress in ITU-T [G.9804.3]. The use of these higher speed PONs will be gated by the economic availability of new technology needed to make them possible.

12.4. LLS using semi-active DWDM wavelength multiplexed links over a power splitter ODN (WS-WDM-PON)

An architecture that is being explored by several operators who have an extensive power splitter PON network is an overlay of DWDM wavelengths on the same Power Splitter ODN (PS-ODN) to serve designated RUs that may be located within the area served by the TDM-PON. The dedicated wavelengths can be an effective way of meeting the high bit rate and low latency requirements of LLS while leveraging the existing PON infrastructure. The main difference of this Wavelength Selected WS-WDM-PON architecture from the typical semi-active DWDM wavelength architecture (Wavelength Routed WR-WDM-PON) is that a power splitter is used as the branching node rather than a wavelength Mux.

There are two added challenges for WS-WDM-PON:

- Higher insertion loss: typical PON optical budget classes range from 29 to 35 dB. Techniques that can help address this target include the use of FEC and higher power optics.
- Wavelength selection on the receive side: this will require a tunable filter at the RU end in addition to the tunable lasers that are part of the traditional DWDM optics.

On the other hand, it is assumed that fewer wavelengths will be needed per PON for WS-WDM-PON than for WR-WDM-PON since the ODN is expected to be shared as an overlay with other TDM-PONs that have existing PON end-points. In most cases, four wavelengths (and at most eight wavelengths) will be sufficient since most of the PON splitter ports are assumed to be serving other applications. The P2P overlay wavelengths can operate at 10 Gb/s or 25 Gb/s.

An illustration for this WDM architecture with a power splitter ODN is shown below. What is not shown is the coexistence on the same fiber of other legacy TDM-PONs. There is no interaction between these, other than the fact that they share a common fiber. But they are on independent wavelengths, just like there are many independent radio frequencies operating in the air at the same time, with no interaction between them.

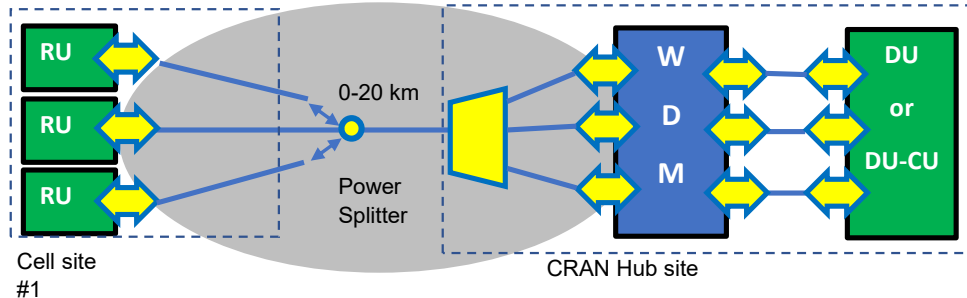

Figure 34: LLS using semi-active DWDM wavelength multiplexed links over a power splitter ODN (WS-WDM-PON).

12.5. LWDM

LWDM (Local Area Network Wavelength Division Multiplexing) is a new WDM technology with the following characteristics:

- Up to 10 km LWDM P2P links
- 25.78 Gb/s / 24.33 Gb/s SFP28
- Dual fiber SFP+, single fiber trunk
- 12 wavelengths @ 800 GHz spacing, i.e., up to 6 SFP+ pairs using the same single trunk fiber
 - L01 236.2 THz 1269.23 nm
 - L02 235.4 THz 1273.54 nm
 - L03 234.6 THz 1277.89 nm
 - L04 233.8 THz 1282.26 nm
 - L05 233.0 THz 1286.66 nm
 - L06 232.2 THz 1291.10 nm
 - L07 231.4 THz 1295.56 nm
 - L08 230.6 THz 1300.05 nm
 - L09 229.8 THz 1304.58 nm
 - L10 229.0 THz 1309.14 nm
 - L11 228.2 THz 1313.73 nm
 - L12 227.4 THz 1318.35 nm
- Wavelength plan example: L01~L06 for RU, L07-L12 for DU/CU

Channel insertion loss: 4 dB for 10 km fiber (0.4 dB/km), 2 dB for connector loss (4*0.5 dB), 4.5 dB per WDM mux/demux pair, total 10.5 dB.

Power consumption class: PC3 (1.8W maximum power dissipation).

Being a new technology, the market impact and deployment volumes are not yet known.

13. Conclusion

Optical solutions are essential enablers for the global 5G rollouts, as they bring capacity and performance needed for 5G transport.

Driven by the acceleration of 5G deployments and consumer adoption, MOPA proposes a common view and understanding of the optical solutions needed for 5G transport (fronthaul and backhaul). The aim is to solve the current challenges faced by operators, system vendors and optical pluggable suppliers—specifically ambiguity and complexity—and enable them to make the right technology choices and focus on the most relevant needs of the industry. MOPA benefits the whole eco-system by ensuring timely, cost-efficient, and optimized architectures.

14. References

- [OptConn] S. Dahlfors, et al. "5G Mobile Pluggables - Blueprints for Global Deployments", <https://opticalconnectionsnews.com/webinars/optical-connections-webinar-series-5g/>
- [M2083] ITU-R Rec. M.2083-0 "IMT Vision – Framework and overall objectives of the future development of IMT for 2020 and beyond", Sept 2015
- [G8300] ITU-T Rec. G.8300: "Characteristics of transport networks to support IMT-2020/5G", May 2020
- [Wiki5G] <https://en.wikipedia.org/wiki/5G>
- [LTEbands] https://en.wikipedia.org/wiki/LTE_frequency_bands
- [NRbands] https://en.wikipedia.org/wiki/5G_NR_frequency_bands
- [TS38306] 3GPP TS 38.306 V16.1.0 (2020-07).
- [TS38470] 3GPP TS 38.470 V16.3.0 (2020-09) "Technical Specification Group Radio Access Network; NG-RAN; F1 general aspects and principles (Release 16)"
- [TS38801] 3GPP TR 38.801 V14.0.0 (2017-03): "Study on new radio access technology: Radio access architecture and interfaces (Release 14)"
- [GSTR-TN5G] ITU-T Technical Report GSTR-TN5G: <http://handle.itu.int/11.1002/pub/8124d287-en>
- [OIF-Thermal] OIF: Implementation Agreement for Thermal Interface Specification for Pluggable Optics Modules, IA # OIF-Thermal-01.0, May 18th 2015
- [ETS-EMC] ETS 300 386, ETSI: Public Telecommunications Network Equipment EMC Requirements
- [FCC15] FCC Part 15, Federal Communications Commission (USA) - Part 15 (Radio Frequency Devices)
- [TDM-PON] https://www.itu.int/en/ITU-T/studygroups/2017-2020/15/Documents/OFC2018-2-Q2_v5.pdf , <https://www.itu.int/rec/T-REC-G.Sup66-202009-I/en>
- [G.698.2] ITU-T Rec. G.698.2 "Amplified multichannel dense wavelength division multiplexing applications with single channel optical interfaces". Nov 2018
- [G.694.2] ITU-T Rec. G.694.2 "Spectral grids for WDM applications: CWDM wavelength grid", Dec 2003
- [G.9802.x] ITU-T Rec. G.9802, G.9802.1, G.9802.2 (work in progress) "Wavelength division multiplexed passive optical networks (WDM PON)"
- [G.9804.x] ITU-T Rec. G.9804.1, G.9804.2, G.9804.3 (work in progress) "Higher speed passive optical networks (HSP)"
- [G.9807.x] ITU-T Rec. G.9807.1, G.9807.2 "10-Gigabit-capable symmetric passive optical network (XGS-PON)"

[G.984.x]	ITU-T Rec. G.984.1, G.984.2, G.984.3, G.984.4, G.984.5, G.984.6, G.984.7 “Gigabit-capable passive optical networks (GPON)”
[G989.x]	ITU-T Rec. G.989.1, G.989.2, G.989.3 “40-Gigabit-capable passive optical networks (NG-PON2)”
[eCPRIreq]	CPRI. “Transport Network V1.2 (2018-06-25) Requirements Specification Common Public Radio Interface: Requirements for the eCPRI Transport Network”
[ORAN-CTI]	O-RAN Technical Specification WG4.CTI-TCP.0-v01.00 “Cooperative Transport Interface Transport Control Plane Specification”, 2020 (v2 2021 pending). O-RAN Technical Specification WG4.CTI-TMP.0-v01.00 “Cooperative Transport Interface Transport Management Plane Specification”, 2020 (v2 2021 pending)
[G.Sup.71]	ITU-T series G Supplement 71 “OLT Capabilities for supporting CO DBA” (publication pending)
[IEC61753]	IEC 61753-021-2, “Fibre optic interconnecting devices and passive components performance standard - Part 021-2: Grade C/3 single-mode fibre optic connectors for category C - Controlled environment”, Dec 2007
IEC 61753-022-2	Fibre optic interconnecting devices and passive components - Performance standard - Part 022-2: Fibre optic connectors terminated on multimode fibre for category C - Controlled environment
[25GSPON]	25G PON MSA group, “25GS-PON Specification: 25 Gigabit Symmetric Passive Optical Network” v2.0, Aug 2021
[10GEAPON]	IEEE 802.3av-2009 “Part 3: Carrier Sense Multiple Access with Collision Detection (CSMA/CD) Access Method and Physical Layer Specifications, Amendment 1: Physical Layer and Management Parameters for 10Gb/s Passive Optical Networks”, Clause 75 IEEE 802.3bk “Amendment 1 to 802.3-2012: Physical Layer Specifications and Management Parameters for Extended Ethernet Passive Optical Networks”
[802.3ca]	IEEE 802.3ca-2020 “Amendment 9: Physical Layer Specifications and Management Parameters for 25 Gb/s and 50 Gb/s Passive Optical Networks”, Clause 141
[SmartT]	smarttunable-msa.org